



# ID5000 Series Smart Code Reader

User Manual

## Legal Information

© 2022 Hangzhou Hikrobot Technology Co., Ltd. All rights reserved.

### About this Manual

The Manual includes instructions for using and managing the Product. Pictures, charts, images and all other information hereinafter are for description and explanation only. The information contained in the Manual is subject to change, without notice, due to firmware updates or other reasons. Please find the latest version of this Manual at the Hikrobot website (<https://en.hikrobotics.com/>). Please use this Manual with the guidance and assistance of professionals trained in supporting the Product.

### Trademarks

**HIKROBOT** and other Hikrobot's trademarks and logos are the properties of Hikrobot in various jurisdictions. Other trademarks and logos mentioned are the properties of their respective owners.

### Disclaimer

TO THE MAXIMUM EXTENT PERMITTED BY APPLICABLE LAW, THIS MANUAL AND THE PRODUCT DESCRIBED, WITH ITS HARDWARE, SOFTWARE AND FIRMWARE, ARE PROVIDED "AS IS" AND "WITH ALL FAULTS AND ERRORS". HIKROBOT MAKES NO WARRANTIES, EXPRESS OR IMPLIED, INCLUDING WITHOUT LIMITATION, MERCHANTABILITY, SATISFACTORY QUALITY, OR FITNESS FOR A PARTICULAR PURPOSE. THE USE OF THE PRODUCT BY YOU IS AT YOUR OWN RISK. IN NO EVENT WILL HIKROBOT BE LIABLE TO YOU FOR ANY SPECIAL, CONSEQUENTIAL, INCIDENTAL, OR INDIRECT DAMAGES, INCLUDING, AMONG OTHERS, DAMAGES FOR LOSS OF BUSINESS PROFITS, BUSINESS INTERRUPTION, OR LOSS OF DATA, CORRUPTION OF SYSTEMS, OR LOSS OF DOCUMENTATION, WHETHER BASED ON BREACH OF CONTRACT, TORT (INCLUDING NEGLIGENCE), PRODUCT LIABILITY, OR OTHERWISE, IN CONNECTION WITH THE USE OF THE PRODUCT, EVEN IF HIKROBOT HAS BEEN ADVISED OF THE POSSIBILITY OF SUCH DAMAGES OR LOSS.

YOU ACKNOWLEDGE THAT THE NATURE OF INTERNET PROVIDES FOR INHERENT SECURITY RISKS, AND HIKROBOT SHALL NOT TAKE ANY RESPONSIBILITIES FOR ABNORMAL OPERATION, PRIVACY LEAKAGE OR OTHER DAMAGES RESULTING FROM CYBER-ATTACK, HACKER ATTACK, VIRUS INFECTION, OR OTHER INTERNET SECURITY RISKS; HOWEVER, HIKROBOT WILL PROVIDE TIMELY TECHNICAL SUPPORT IF REQUIRED.

YOU AGREE TO USE THIS PRODUCT IN COMPLIANCE WITH ALL APPLICABLE LAWS, AND YOU ARE SOLELY RESPONSIBLE FOR ENSURING THAT YOUR USE CONFORMS TO THE APPLICABLE LAW. ESPECIALLY, YOU ARE RESPONSIBLE, FOR USING THIS PRODUCT IN A MANNER THAT DOES NOT INFRINGE ON THE RIGHTS OF THIRD PARTIES, INCLUDING WITHOUT LIMITATION, RIGHTS OF PUBLICITY, INTELLECTUAL PROPERTY RIGHTS, OR DATA PROTECTION AND OTHER PRIVACY RIGHTS. YOU SHALL NOT USE THIS PRODUCT FOR ANY PROHIBITED END-USES, INCLUDING THE DEVELOPMENT OR PRODUCTION OF WEAPONS OF MASS DESTRUCTION, THE DEVELOPMENT OR PRODUCTION OF CHEMICAL OR BIOLOGICAL WEAPONS, ANY ACTIVITIES IN THE CONTEXT RELATED TO ANY NUCLEAR EXPLOSIVE OR UNSAFE NUCLEAR FUEL-CYCLE, OR IN SUPPORT OF HUMAN RIGHTS ABUSES.

THE PERFORMANCE DATA IN THIS PUBLICATION IS BASED ON HIKROBOT'S INTERNAL RESEARCH/EVALUATION. ACTUAL DATA MAY VARY DEPENDING ON SPECIFIC CONFIGURATIONS AND OPERATING CONDITIONS AND HIKROBOT SHALL NOT BEAR THE CONSEQUENCES ARISING THEREFROM.

IN THE EVENT OF ANY CONFLICTS BETWEEN THIS MANUAL AND THE APPLICABLE LAW, THE LATER PREVAILS.

## Regulatory Information

### FCC Information

Please take attention that changes or modification not expressly approved by the party responsible for compliance could void the user's authority to operate the equipment.

FCC compliance: This equipment has been tested and found to comply with the limits for a Class A digital device, pursuant to part 15 of the FCC Rules. These limits are designed to provide reasonable protection against harmful interference in a residential installation. This equipment generates, uses and can radiate radio frequency energy and, if not installed and used in accordance with the instructions, may cause harmful interference to radio communications. However, there is no guarantee that interference will not occur in a particular installation. If this equipment does cause harmful interference to radio or television reception, which can be determined by turning the equipment off and on, the user is encouraged to try to correct the interference by one or more of the following measures:

- Reorient or relocate the receiving antenna.
- Increase the separation between the equipment and receiver.
- Connect the equipment into an outlet on a circuit different from that to which the receiver is connected.
- Consult the dealer or an experienced radio/TV technician for help.

#### FCC Conditions

This device complies with part 15 of the FCC Rules. Operation is subject to the following two conditions:

- This device may not cause harmful interference.
- This device must accept any interference received, including interference that may cause undesired operation.

### EU Conformity Statement



This product and - if applicable - the supplied accessories too are marked with "CE" and comply therefore with the applicable harmonized European standards listed under the EMC Directive 2014/30/EU, LVD Directive 2014/35/EU, the RoHS Directive 2011/65/EU.






2012/19/EU (WEEE directive): Products marked with this symbol cannot be disposed of as unsorted municipal waste in the European Union. For proper recycling, return this product to your local supplier upon the purchase of equivalent new equipment, or dispose of it at designated collection points. For more information see: <http://www.recyclethis.info>.



2006/66/EC (battery directive): This product contains a battery that cannot be disposed of as unsorted municipal waste in the European Union. See the product documentation for specific battery information. The battery is marked with this symbol, which may include lettering to indicate cadmium (Cd), lead (Pb), or mercury (Hg). For proper recycling, return the battery to your supplier or to a designated collection point. For more information see: <http://www.recyclethis.info>.

## Symbol Conventions

The symbols that may be found in this document are defined as follows.

| Symbol   | Description   |
|--|---|
|  <b>Danger</b>  | Indicates a hazardous situation which, if not avoided, will or could result in death or serious injury.   |
|  <b>Caution</b> | Indicates a potentially hazardous situation which, if not avoided, could result in equipment damage, data loss, performance degradation, or unexpected results. |
|  <b>Note</b>   | Provides additional information to emphasize or supplement important points of the main text.   |

## Available Model

This manual is applicable to the ID5000 Series Smart Code Reader.

## Safety Instruction

These instructions are intended to ensure that the user can use the product correctly to avoid danger or property loss.

### Laws and Regulations

The device should be used in compliance with local laws, electrical safety regulations, and fire prevention regulations.

### Light Source

- This device has a retinal blue light hazard that belongs to the class II hazard. Do not observe the device in close range during its operation.
- The retinal blue light hazard (small light source) of the white light lamp measured at 200 mm is 7.965e0 W/m<sup>2</sup>, and the hazard limit measured at the minimum safety distance of 570 mm is 9.637e-1 W/m<sup>2</sup>.
- Protective measures like wearing safety goggles are required when installing, maintaining and debugging the device.
- In the absence of proper protection, you should keep safety distance with the light source, or avoid direct eye exposure with the light source during device installation and maintenance.

### **Power Supply**

- When wiring or dismantling, make sure that the device power is cut off, and do not operate under electrification.
- Avoid contact with exposed circuit. When the device is powered on, avoid contact with exposed junctions and parts.
- DO NOT connect multiple devices to one power adapter, to avoid over-heating or fire hazards caused by overload.
- Make sure the plug is properly connected to the power socket.

### **Transportation**

- The product contains precision optical components and electronic components. During transportation, storage and installation, incorrect operations like heavy pressure and violent vibration should be avoided. Otherwise, the product may be damaged.
- Avoid sudden collision, and pack the product with the accompanied carton and cushioning material or similar package.

### **Using Environment**

- Do not touch the heat-radiating part of the device to avoid scalding.
- In order to reduce the risk of fire or electric shock, do not let the product get wet or damp.
- Do not drop objects onto the product and avoid vigorous vibration.
- Keep the product away from magnetic interference.
- Do not use the product in extremely heat, extremely cold, dusty environment, corrosive environment or high humidity environment.
- Do not aim the product lens at objects of strong light, such as the sun and incandescent lamp. Otherwise, the lens may be damaged.
- The product should be stored in dry environment without corrosive gas. Avoid placing the product in direct sunlight and poorly ventilated locations, or near heat sources such as heater or heating (ignoring this warning may lead to fire hazards).
- Do not operate in explosive environment.
- Keep the surrounding area well ventilated to avoid heat accumulation. Do not contact the radiator directly to avoid scald.

### **Electrostatic Protection**

- Remove all conductive objects (such as jewelry, watch, etc.) on the product body before touching the product, and touch the grounding metal bracket by hand to release the static electricity.
- It is suggested to wear anti-static suit to prevent damage to the equipment caused by static electricity.
- When installing or maintaining the product, please wear anti-static wrist band or anti-static gloves. Make sure that the wristband is tightly attached to the skin and is reliably grounded.
- It is forbidden to touch exposed circuit boards with bare hands. Static electricity generated by human body may damage electrostatic sensitive components on circuit boards.
- When touching electrostatic sensitive components or devices, proper grounding measures must be taken.

- Put electrostatic sensitive components into anti-static bags for protection.
- It is suggested to place humidifier in dry environment to maintain suitable humidity and reduce static electricity generation.

### **Maintenance**

- If the product is not working properly, contact the store or the nearest service center. Do not disassemble or modify the device in any way. (The company does not bear any liability for any problem arising from unauthorized modification or maintenance).
- Please properly preserve all the original packaging materials of the product so that when problems arise, the product can be packed with packaging materials and sent to the agent or returned to the manufacturer for processing. The company does not bear any liability for accidental damage during transportation caused by non-original packaging.
- This product is a precision electronic device, no components can be maintained by user, please do not disassemble the device arbitrarily.

### **Cleaning**

Please do not touch the image sensor directly. If the sensor needs to be cleaned, please use a clean rag and wet it with alcohol, then gently wipe off the dirt; if the device is not in use, please cover the image sensor with dust cover for protection.

### **Installation**

Please do not install the product on vibrating surface or places that are vulnerable to impact.

### **Personnel Requirement**

Quality requirements for installation and maintenance personnel: qualification certificate or working experience in weak current system installation and maintenance, and relevant working experience and qualifications. Besides, the personnel must possess the following knowledge and operation skills:

- The basic knowledge and operation skills of low voltage wiring and Low voltage electronic circuit connection.
- The ability to comprehend the contents of this manual.

## **Contact Information**

Hangzhou Hikrobot Technology Co., Ltd.  
No. 399 Danfeng Road, Binjiang District, Hangzhou, 310051, China  
E-mail: [tech\\_support@hikrobotics.com](mailto:tech_support@hikrobotics.com)  
Website: <https://en.hikrobotics.com/>

# Contents

|  |           |
|--|-----------|
| <b>Chapter 1 Appearance</b> .....              | <b>1</b>  |
| <b>Chapter 2 Interface and Indicator</b> ..... | <b>4</b>  |
| 2.1 12-Pin Interface .....                     | 4         |
| 2.2 Indicator Status .....                     | 5         |
| <b>Chapter 3 I/O Wiring</b> .....              | <b>6</b>  |
| 3.1 Input Signal .....                         | 6         |
| 3.2 Output Signal .....                        | 7         |
| 3.3 Input Signal Wiring .....                  | 8         |
| 3.4 Output Signal Wiring .....                 | 9         |
| 3.5 RS-232 Serial Port .....                   | 11        |
| <b>Chapter 4 Installation</b> .....            | <b>12</b> |
| 4.1 Installation Preparation .....             | 12        |
| 4.2 Install Device .....                       | 12        |
| <b>Chapter 5 Device Connection</b> .....       | <b>15</b> |
| 5.1 Install Client Software .....              | 15        |
| 5.2 Turn off Firewall .....                    | 16        |
| 5.3 Set PC Network .....                       | 16        |
| 5.4 Set Device Network .....                   | 17        |
| 5.5 Connect Device to Client Software .....    | 18        |
| <b>Chapter 6 Client Software Layout</b> .....  | <b>19</b> |
| <b>Chapter 7 Device Mode Settings</b> .....    | <b>21</b> |
| <b>Chapter 8 Device Settings</b> .....         | <b>23</b> |
| 8.1 Image Quality Settings .....               | 23        |
| 8.1.1 Set Image .....                          | 23        |
| 8.1.2 Set Exposure .....                       | 25        |
| 8.1.3 Set Gain .....                           | 26        |
| 8.1.4 Set Polling .....                        | 28        |
| 8.1.5 Set Light Source .....                   | 30        |
| 8.1.6 Set Lens Focus .....                     | 32        |

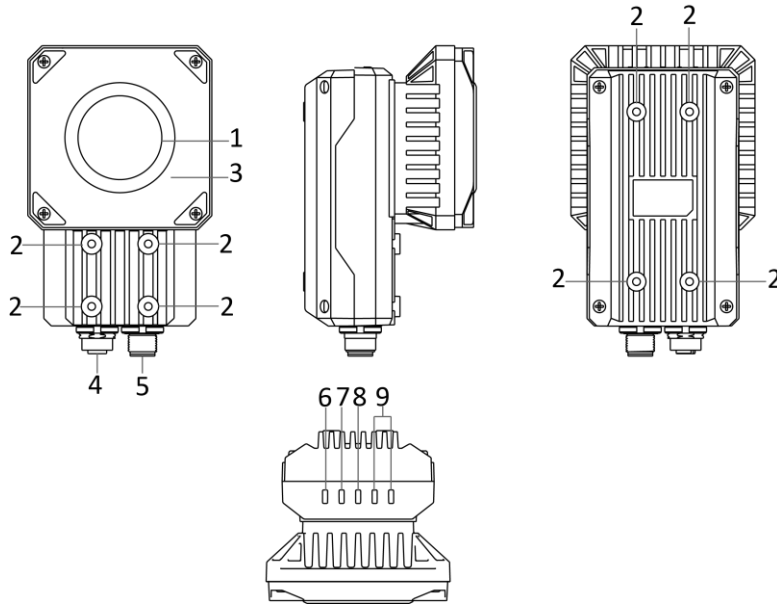
|   |    |
|---|----|
| 8.1.7 Set Self-Adaptive Adjustment .....        | 33 |
| 8.1.8 Set Mirror X .....                        | 34 |
| 8.1.9 Set Test Pattern .....                    | 35 |
| 8.2 Code Algorithm Settings .....               | 35 |
| 8.2.1 Add Code .....                            | 35 |
| 8.2.2 Set Code Reading ROI .....                | 36 |
| 8.2.3 Set 1D Algorithm Parameter .....          | 39 |
| 8.2.4 Set 2D Algorithm Parameter .....          | 40 |
| 8.2.5 Set 2D Code Quality Evaluation .....      | 43 |
| 8.2.6 Set Code Score .....                      | 44 |
| 8.3 Signal Input Settings .....                 | 45 |
| 8.3.1 Set Trigger Mode .....                    | 45 |
| 8.3.2 Enable Internal Trigger Mode .....        | 46 |
| 8.3.3 Enable External Trigger Mode .....        | 46 |
| 8.3.4 Stop Trigger .....                        | 51 |
| 8.4 Signal Output Settings .....                | 54 |
| 8.4.1 Select Output Signal .....                | 54 |
| 8.4.2 Enable Line Inverter .....                | 55 |
| 8.4.3 Set Event Source .....                    | 55 |
| 8.5 Indicator Customization .....               | 64 |
| 8.6 Code Reading Result Settings .....          | 65 |
| 8.6.1 Set Code Reading Result Output Mode ..... | 65 |
| 8.6.2 Set Filter Rule .....                     | 65 |
| 8.6.3 Set Result Format .....                   | 68 |
| 8.7 Contrast Control Settings .....             | 74 |
| 8.8 Communication Settings .....                | 76 |
| 8.8.1 Smart SDK .....                           | 76 |
| 8.8.2 TCP Client .....                          | 77 |
| 8.8.3 TCP Server .....                          | 77 |
| 8.8.4 Serial .....                              | 78 |
| 8.8.5 FTP .....                                 | 78 |

|   |           |
|---|-----------|
| 8.8.6 Profinet .....  | 78        |
| 8.8.7 MELSEC.....   | 79        |
| 8.8.8 Ethernet/IP .....   | 80        |
| 8.8.9 ModBus .....  | 80        |
| 8.8.10 Fins .....   | 81        |
| 8.8.11 SLMP .....   | 83        |
| 8.9 User Set Customization .....  | 84        |
| 8.10 Statistics Information .....   | 85        |
| 8.11 Event Report .....   | 86        |
| <b>Chapter 9 Device Operation .....</b>   | <b>88</b> |
| 9.1 Live View .....   | 88        |
| 9.2 Enable Acquisition .....  | 88        |
| 9.3 Add Cross Line .....  | 89        |
| 9.4 Start Recording .....   | 89        |
| 9.5 Split Window .....  | 90        |
| 9.6 View Reports.....   | 90        |
| 9.7 View Log.....   | 91        |
| 9.8 Set Time .....  | 91        |
| 9.9 Enable Device Auto Work .....   | 92        |
| <b>Chapter 10 Device Maintenance .....</b>                                      | <b>93</b> |
| 10.1 Update Firmware.....   | 93        |
| 10.2 Reboot Device.....   | 93        |
| <b>Chapter 11 FAQ (Frequently Asked Question) .....</b>                         | <b>95</b> |
| 11.1 Why the image is very dark? .....  | 95        |
| 11.2 Why the image's frame rate is very low in the live view? .....             | 95        |
| 11.3 Why there is no device listed after I run the IDMVS client software? ..... | 95        |
| 11.4 Why there is no image in the live view? .....                              | 96        |
| 11.5 Why codes within the field of view cannot be recognized? .....             | 96        |
| <b>Chapter 12 Revision History .....</b>  | <b>97</b> |

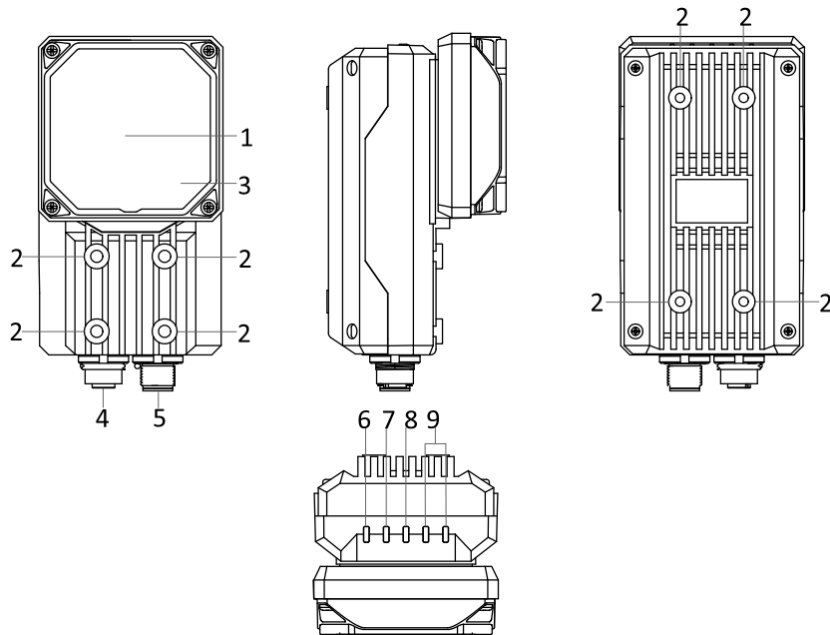
# Chapter 1 Appearance

**Note**

Appearance here is for reference only. Refer to the device's specification for detailed dimension information.



**Figure 1-1 Appearance (Type I)**



**Figure 1-2 Appearance (Type II)**

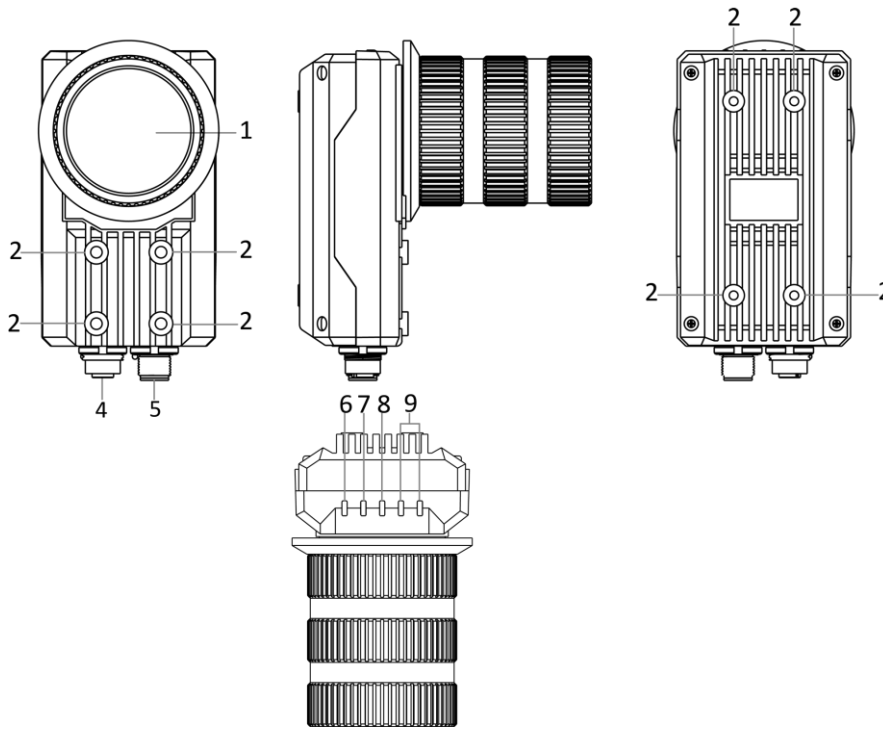


Figure 1-3 Appearance (Type III)

Table 1-1 Component Description

| No. | Name                       | Description   |
|-----|----------------------------|---|
| 1   | Lens Cap                   | It can be replaced with other lens cap. Transparent and polarization lens cap are optional.   |
| 2   | Screw Hole                 | It is used to fix the device to installation position. It is recommended to use M4 screw.   |
| 3   | Light Source               | It refers to LED lamps providing light for improving code reading effect.<br><b>Note</b> <ul style="list-style-type: none"> <li>The default color of LED lamps is white. Red, blue and IR are optional.</li> <li>The quantity of LED lamps may differ by device models.</li> <li>The light source of type II device supports full polarization, half polarization, and none polarization.</li> <li>The type III device does not have own light source, and you can use an external light source instead.</li> </ul> |
| 4   | Gigabit Ethernet Interface | It refers to gigabit Ethernet interface for transmitting data. The interface is designed with screw threads to tighten connection between the device and cable, and thus avoiding influence caused by vibration.  |
| 5   | 12-Pin Interface           | It provides power, input/output, and serial port signal. The interface is designed with screw threads to tighten connection between the device and cable, and thus avoiding influence caused by vibration.  |

| No. | Name            | Description   |
|-----|-----------------|---|
| 6   | PWR Indicator   | It is the power indicator. The indicator is solid blue when the device operates normally.   |
| 7   | LNK Indicator   | It is network connection indicator. The indicator is solid green when the network transmission is normal.   |
| 8   | ACT Indicator   | It is network transmission indicator. The indicator is flashing yellow when the network transmission is normal. The indicator flashing speed is related with data transmission speed. |
| 9   | U1/U2 Indicator | The device has 2 user indicators, U1 and U2. They are used to indicate whether some functions of the device are normal or not.  |

## Chapter 2 Interface and Indicator

### 2.1 12-Pin Interface

Read the following section to get definitions of 12-pin interface.

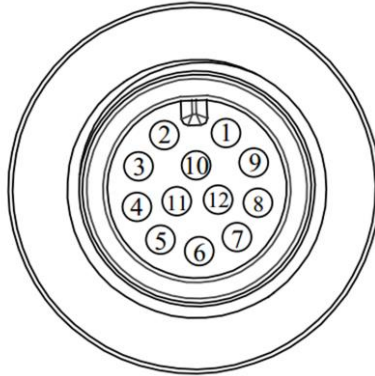


Figure 2-1 12-Pin Interface

Table 2-1 Pin Definitions

| No. | Signal    | I/O Signal Source          | Description                          | Color     |
|-----|-----------|----------------------------|--------------------------------------|-----------|
| 1   | DC-PWR    | --                         | Direct current power supply positive | White     |
| 2   | GND       | --                         | Power supply ground                  | Brown     |
| 3   | OPTO_OUT0 | LineOut0 signal line       | Opto-isolated output 0               | Green     |
| 4   | OPTO_OUT1 | LineOut1 signal line       | Opto-isolated output 1               | Yellow    |
| 5   | OPTO_OUT2 | LineOut2 signal line       | Opto-isolated output 2               | Gray      |
| 6   | OUT_COM   | LineOut0/1/2 signal ground | Common-ended output                  | Pink      |
| 7   | OPTO_IN0  | LineIn0 signal line        | Opto-isolated input 0                | Blue      |
| 8   | OPTO_IN1  | LineIn1 signal line        | Opto-isolated input 1                | Red       |
| 9   | OPTO_IN2  | LineIn2 signal line        | Opto-isolated input 2                | Black     |
| 10  | IN_COM    | LineIn0/1/2 signal ground  | Common-ended input                   | Purple    |
| 11  | RS232_R   | --                         | RS232 serial port input              | Red/Blue  |
| 12  | RS232_T   | --                         | RS232 serial port output             | Gray/Pink |

 **Note**

You should refer to the table above and the label attached to the power and I/O cable to wire the device.

## 2.2 Indicator Status

Read the following section to get the indicator status of the device.

**Table 2-2 Description**

| Device Status              | PWR Indicator | LNK Indicator | ACT Indicator             | U1/U2                                      |
|----------------------------|---------------|---------------|---------------------------|--|
| Device is powered on.      | Solid blue    | Solid green   | Slow/fast flashing yellow | U1 is unlit, and U2 is slow flashing blue. |
| Power supply exception.    | Unlit         |               |                           |  |
| Network exception.         | Solid blue    | Unlit         |                           | U1 is unlit, and U2 is slow flashing blue. |
| Device software exception. | Solid blue    | Solid green   | Flashing yellow           | U1 and U2 are unlit.                       |
| Device exception           | Solid blue    | Solid green   | Solid yellow              | U1 and U2 are solid blue.                  |

 **Note**

When the indicators are flashing slowly, its unlit interval is 1 s.

## Chapter 3 I/O Wiring

### 3.1 Input Signal

The device's LineIn 0/1/2 is opto-isolated input, and their internal circuit is as follows.

**Note**

- The input voltage ranges from 5 VDC to 30 VDC.
- The maximum current is 25 mA.
- The breakdown voltage is 36 VDC. Keep voltage stable.

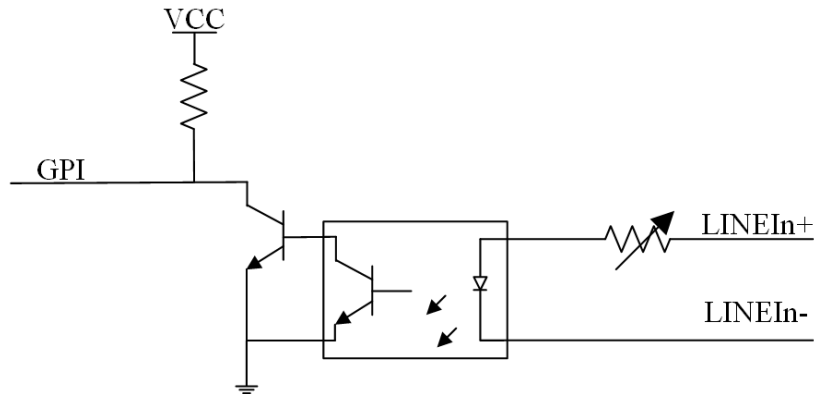


Figure 3-1 Internal Circuit of Input Signal

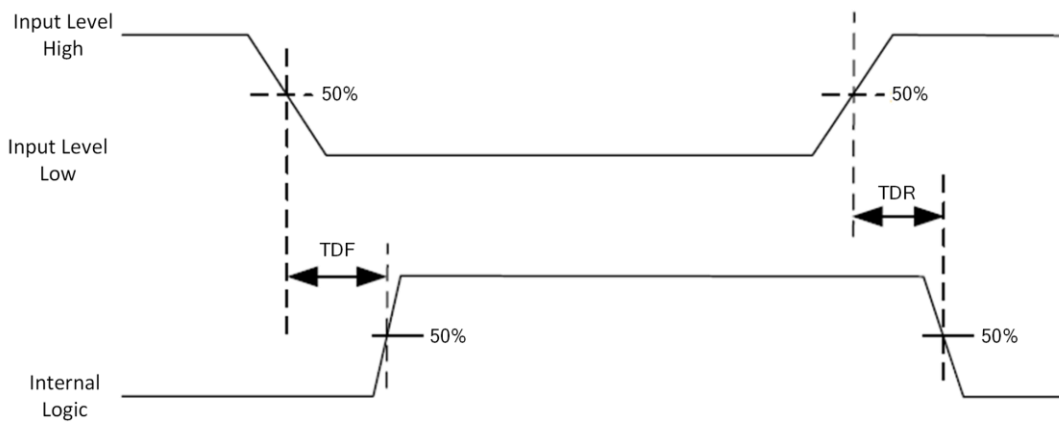


Figure 3-2 Input Logic Level

**Table 3-1 Input Electrical Feature**

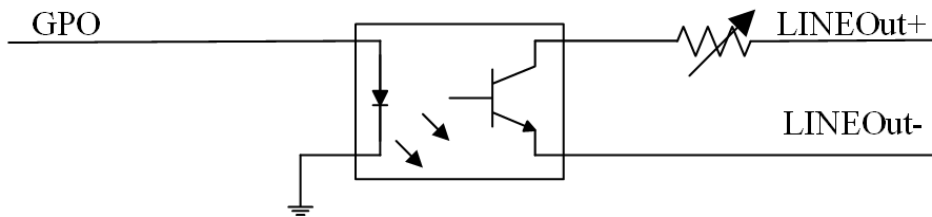
| Parameter Name         | Parameter Symbol | Value        |
|------------------------|------------------|--------------|
| Input Logic Level Low  | VL               | 1.5 VDC      |
| Input Logic Level High | VH               | 2 VDC        |
| Input Falling Delay    | TDF              | 81.6 $\mu$ s |
| Input Rising Delay     | TDR              | 7 $\mu$ s    |

### 3.2 Output Signal

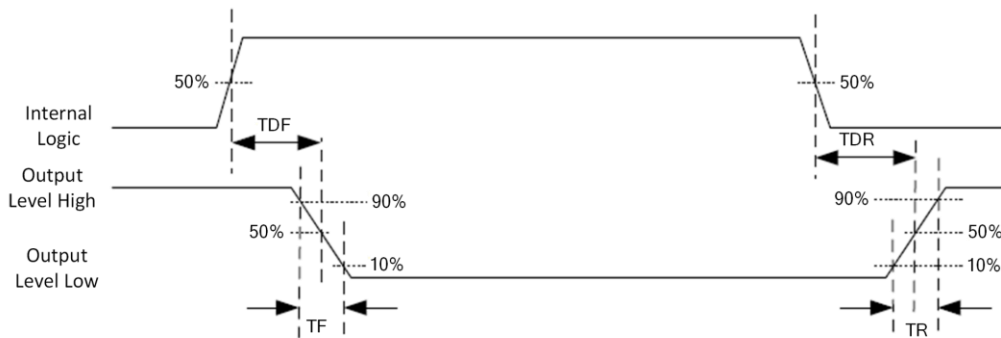
The device's LineOut 0/1/2 is opto-isolated output, and their internal circuit is as follows.

**Note**

- The output voltage ranges from 5 VDC to 30 VDC.
- The maximum current is 25 mA.
- Do not directly connect with inductive load (e.g. DC motor, etc.) when outputting.



**Figure 3-3 Internal Circuit of Output Signal**



**Figure 3-4 Output Logic Level**

**Note**

If the external voltage and resistance change, the corresponding current of output signal and output logic level low may differ.

**Table 3-2 Output Electrical Feature**

| Parameter Name          | Parameter Symbol | Value       |
|-------------------------|------------------|-------------|
| Output Logic Level Low  | VL               | 730 mV      |
| Output Logic Level High | VH               | 3.2 VDC     |
| Output Falling Delay    | TDF              | 6.3 $\mu$ s |
| Output Rising Delay     | TDR              | 68 $\mu$ s  |
| Output Falling Time     | TF               | 3 $\mu$ s   |
| Output Rising Time      | TR               | 60 $\mu$ s  |

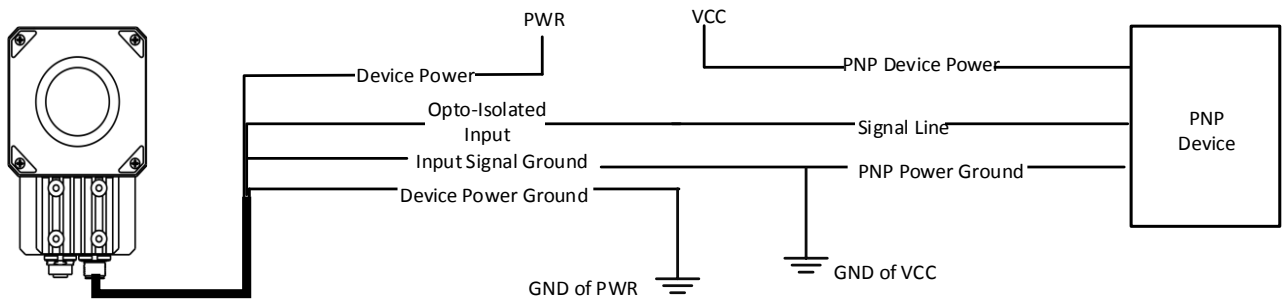
### 3.3 Input Signal Wiring

The device can receive external input signal via I/O interface, and here we take LineIn 0 and type I device as an example to introduce input signal wiring.

**Note**

Input signal wiring may differ with different types of external devices.

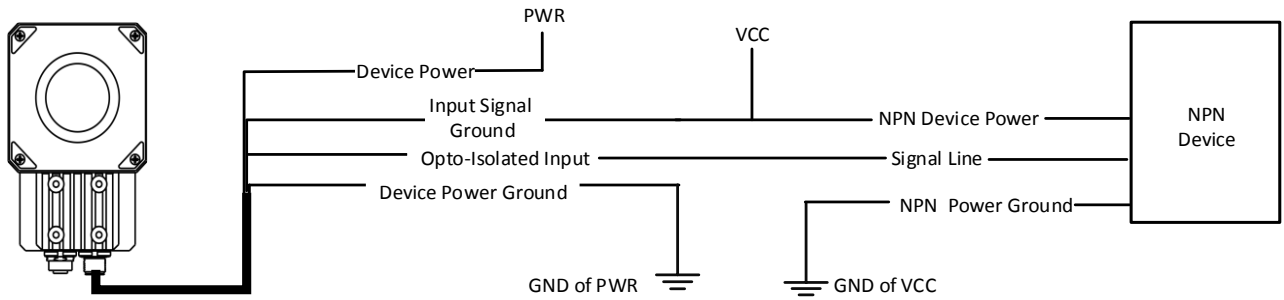
#### PNP Device



**Figure 3-5 Input Signal Connecting to PNP Device**

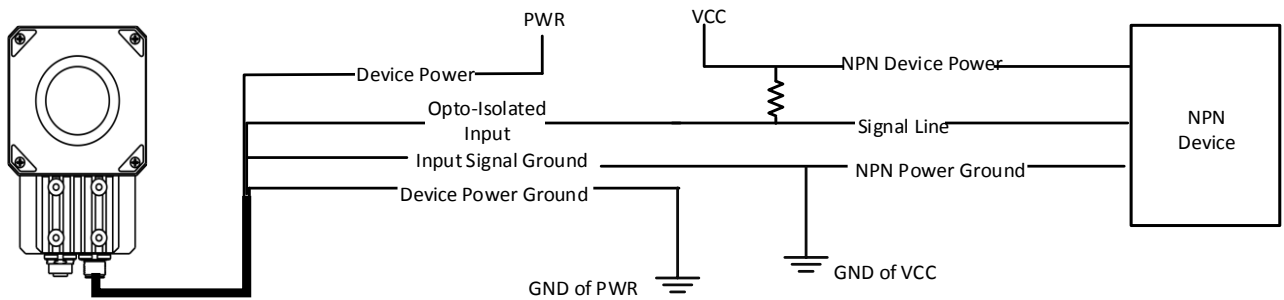
#### NPN Device

If the VCC of NPN device is 12 VDC or 24 VDC and pull-up resistor is not used, its wiring is as follows.



**Figure 3-6 Input Signal Connecting to NPN Device without Pull-Up Resistor**

If the VCC of NPN device is 12 VDC or 24 VDC and 1 K $\Omega$  pull-up resistor is used, its wiring is as follows.



**Figure 3-7 Input Signal Connecting to NPN Device with Pull-Up Resistor**

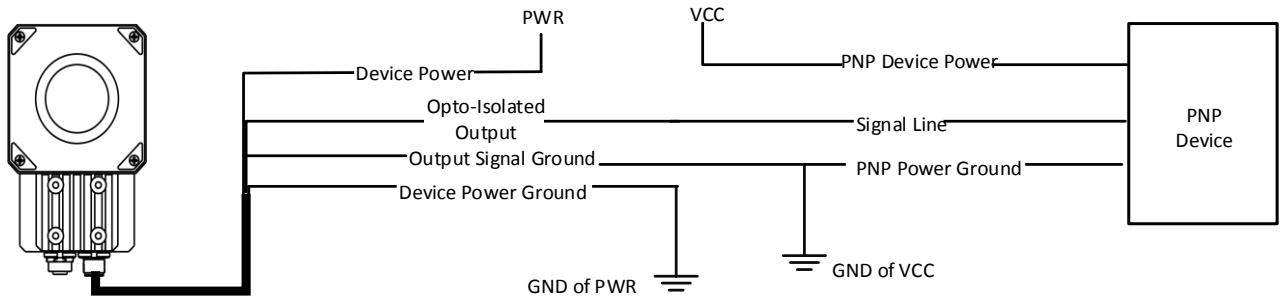
### 3.4 Output Signal Wiring

The device can output signal to external device via I/O interface, and here we take LineOut 0 and type I device as an example to introduce output signal wiring.

**Note**

- Output signal wiring may differ with different types of external devices.
- The voltage of VCC should not higher than that of PWR. Otherwise, the device's output signal may have exception.

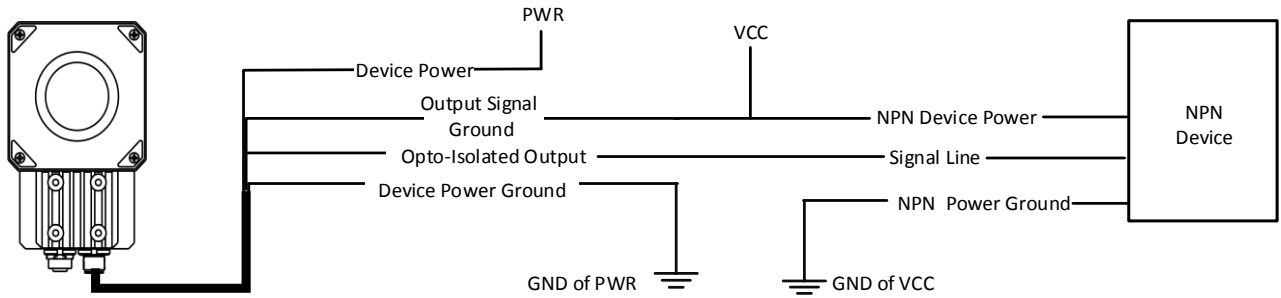
**PNP Device**



**Figure 3-8 Output Signal Connecting to PNP Device**

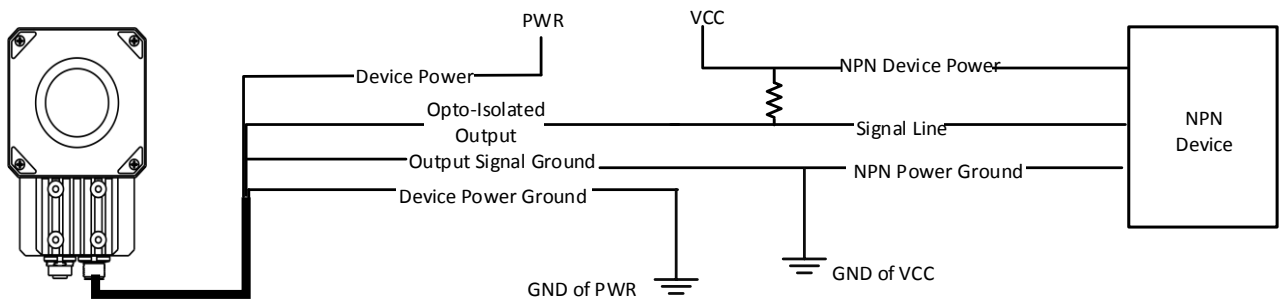
**NPN Device**

If the VCC of NPN device is 12 VDC or 24 VDC and pull-up resistor is not used, its wiring is as follows.



**Figure 3-9 Output Signal Connecting to NPN Device without Pull-Up Resistor**

If the VCC of NPN device is 12 VDC or 24 VDC and 1 K $\Omega$  pull-up resistor is used, its wiring is as follows.



**Figure 3-10 Output Signal Connecting to NPN Device with Pull-Up Resistor**

### 3.5 RS-232 Serial Port

The device supports output via RS-232 serial port. The 9-pin male connector and 25-pin male connector are commonly used serial ports, as shown below. You can refer to the table below for the specific pin name and function.

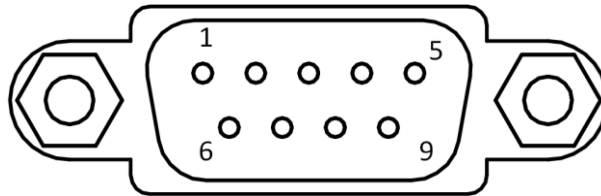


Figure 3-11 9-Pin Interface

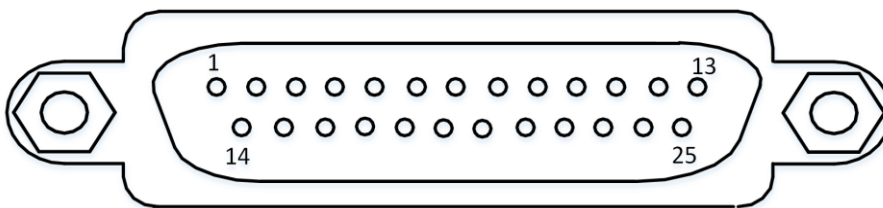


Figure 3-12 25-Pin Interface

Table 3-3 Description

| Serial Port Type | Pin No. | Name | Function      |
|------------------|---------|------|---------------|
| 9-Pin Interface  | 2       | RX   | Receive data  |
|                  | 3       | TX   | Send data     |
|                  | 5       | GND  | Signal ground |
| 25-Pin Interface | 2       | TX   | Send data     |
|                  | 3       | RX   | Receive data  |
|                  | 7       | GND  | Signal ground |

You can refer to the serial port wiring below to connect the device with an external device.

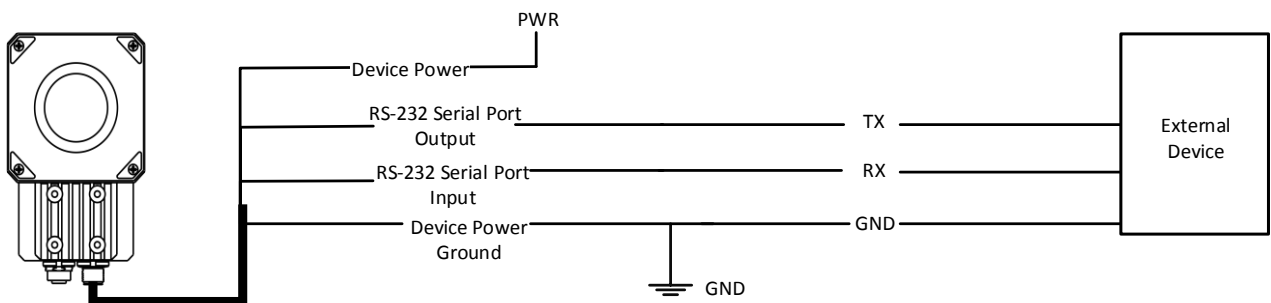



Figure 3-13 RS-232 Serial Port Wiring

## Chapter 4 Installation

### 4.1 Installation Preparation

You need to prepare following accessories before installation.

**Table 4-1 Accessories**

| No. | Name                   | Quantity | Description  |
|-----|------------------------|----------|--|
| 1   | Power and I/O Cable    | 1        | It refers to the 3-meter 12-pin power and I/O cable, and is included in the package.   |
| 2   | Network Cable          | 1        | It refers to the 3-meter GigE network cable with RJ45 connector and aviation connector. It is included in the package.   |
| 3   | DC Switch Power Supply | 1        | It refers to DC switch power supply of 24 VDC and above 1A/2A. Refer to the specification of the device for detailed power supply information. You need to purchase separately.  |
| 4   | Lens                   | 1        | It refers to C-mount lens that you need to purchase it separately. The C-mount lens is used for the type III device.<br> <b>Note</b><br>The type II device is equipped with M12-mount lens. |
| 5   | Light Source           | 1        | It is used to provide light during image acquisition. You need to purchase separately.   |
| 6   | Fixed Bracket          | 1        | It is used to fix the device. You need to purchase separately.   |
| 7   | M4 Screw               | 4        | It refers to the supplied M4 screw that is used to fix the device to installation position.  |

### 4.2 Install Device

#### Before You Start

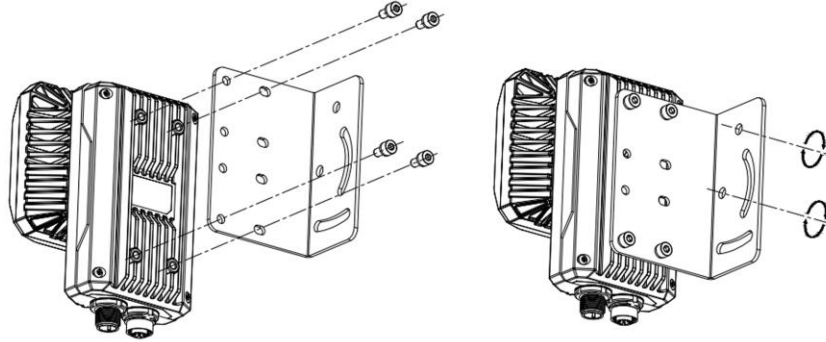
- Make sure the device in the package is in good condition and all the assembly parts are included.
- Make sure that all the related devices are powered off during the installation.

#### Note

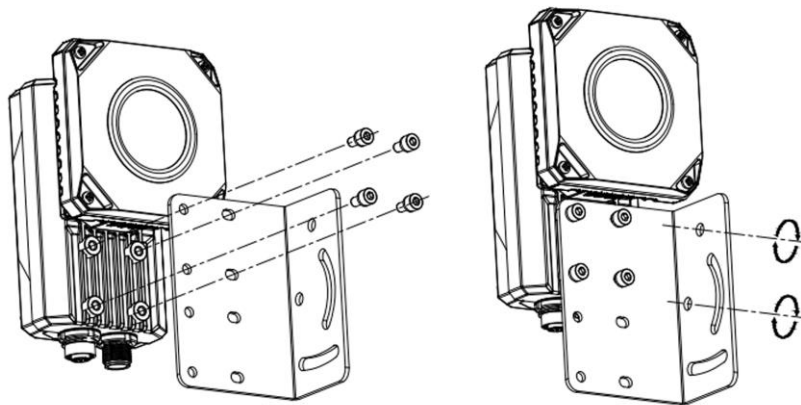
Here we take the type I device as an example for introducing installation.

**Steps**

1. Use M4 screw to fix the device to fixed bracket.
2. Select one of installation methods, and install the device to the installation position.

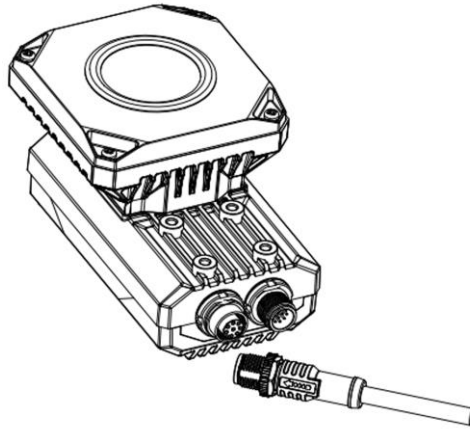


**Figure 4-1 Rear Installation**



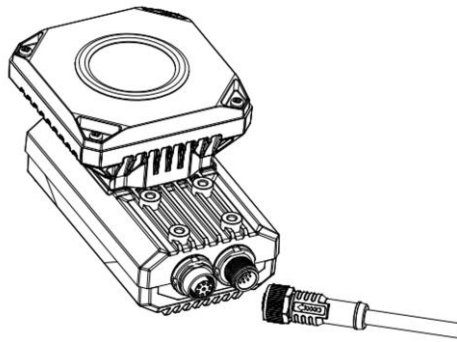
**Figure 4-2 Front Installation**

3. Use GigE network cable with RJ45 aviation connector to connect the device to a switch or a network interface card.



**Figure 4-3 Gigabit Ethernet Interface Wiring**

4. Use power and I/O cable to connect the device to a DC switch power supply.



**Figure 4-4 Power and I/O Wiring**

## Chapter 5 Device Connection

Device connection to the client software is required for device's configuration and remote operations. This section introduces how to install the client software, set PC network, connect the device to the client software, etc.

### 5.1 Install Client Software

IDMVS is a client software for device configuration and remote operations.

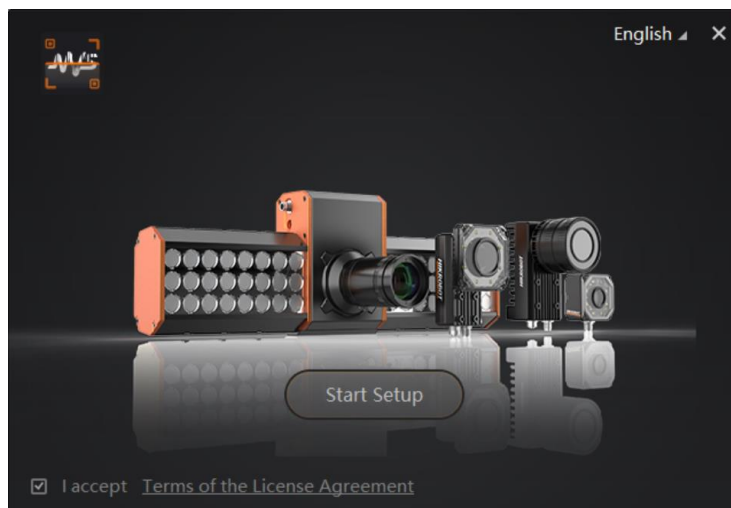
#### Steps

---

#### Note

- Check the Windows version. The client software is compatible with 32/64-bit Windows XP/7/10.
  - You can download the client software installation package from <https://en.hikrobotics.com/>.
  - The graphic user interface may differ by versions of client software you use.
- 

1. Double click the installation package to start installing the client software.
2. Select the language.
3. Read and check **Terms of the License Agreement**.
4. Click **Start Setup**.
5. Select installation directory and click **Next**.



**Figure 5-1 Installation Interface**

6. Finish the installation according to the interface prompts.

## 5.2 Turn off Firewall

To ensure stable client running and image transmission, you are recommended turning off Windows firewall before using the client software.

### Steps

---

#### Note

For different Windows versions, the path name or interface may differ. Please refer to the actual condition.

---

1. Go to Windows Firewall.

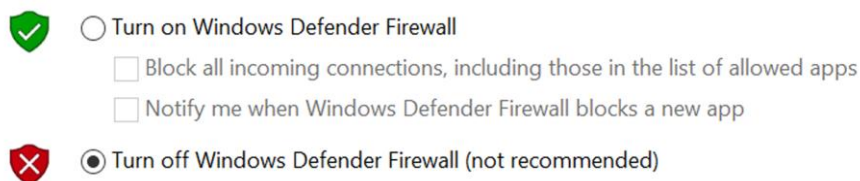
Windows XP system: Click **Start** → **Control Panel** → **Security Center** → **Windows Firewall**.

Windows 7 system: Click **Start** → **Control Panel** → **Windows Firewall**.

Windows 10 system: Click **Start** → **Control Panel** → **System and Security** → **Windows Defender Firewall**.

2. Click **Turn Windows Defender Firewall on or off** on the left.

3. Select **Turn off Windows Defender Firewall (not recommended)**.



**Figure 5-2 Windows Defender Firewall**

4. Click **OK**.

## 5.3 Set PC Network

To ensure stable image transmission and normal communication between the PC and the device via client software, you need to set the PC network before using the client software.

### Steps

---

#### Note

For different Windows versions, the specific setting path and interface may differ. Please refer to the actual condition.

---

1. Go to PC network settings page: **Start** → **Control Panel** → **Network and Internet** → **Network and Sharing Center** → **Change adapter settings**.

2. Select NIC and set the IP obtainment mode.

- Select **Obtain an IP address automatically** to get an IP address of the PC automatically.
- Or select **Use the following IP address** to set an IP address for the PC manually.

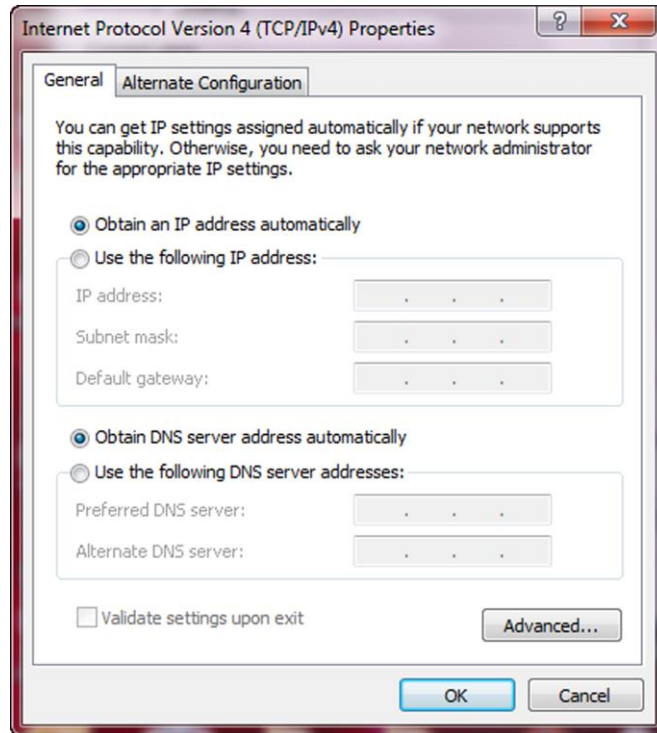


Figure 5-3 Set PC Network


### 3. Set NIC property.

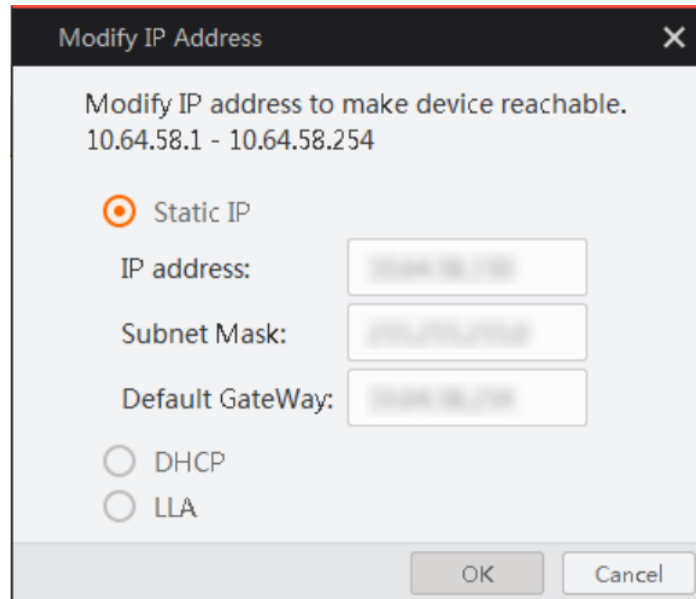
- 1) Go to NIC settings page: **Control Panel** → **Hardware and Sound** → **Device Manager** → **Network Adapter**.
- 2) Select corresponding network interface card, and click **Advanced**.
- 3) Set **Jumbo Packet** value to 9014 Bytes.

## 5.4 Set Device Network

You can set and operate the device in the client software only when the device is in the same network segment with the PC where the client software is installed.

### Steps

1. Double click the client software to run it.
2. Click  to find the device.
3. Right click the device to be connected.
4. Click **Modify IP**.
5. Set the IP address of the device in the same network segment with the PC.




**Figure 5-4 Modify IP Address**

6. Click **OK**.

## 5.5 Connect Device to Client Software

Make sure that your device IP address is in the same network segment with the PC where you installed the client software before connecting the device to it.

Double click the device name in the device list, or click  to connect the device to the client.

## Chapter 6 Client Software Layout

After connecting to the device, the client software can read the device information and display it.

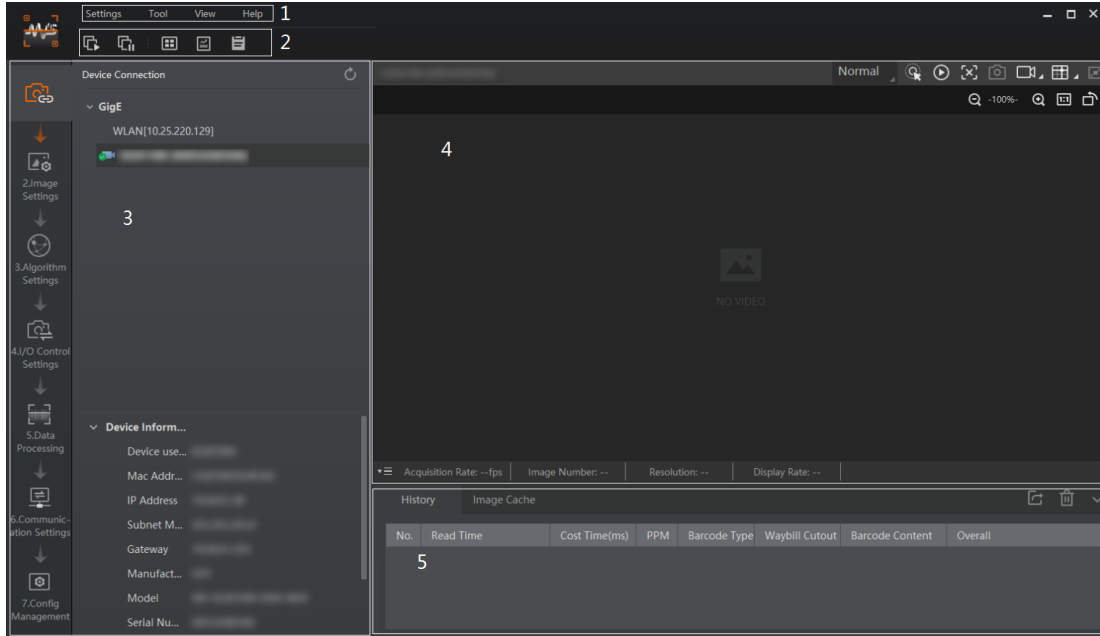


Figure 6-1 Main Window

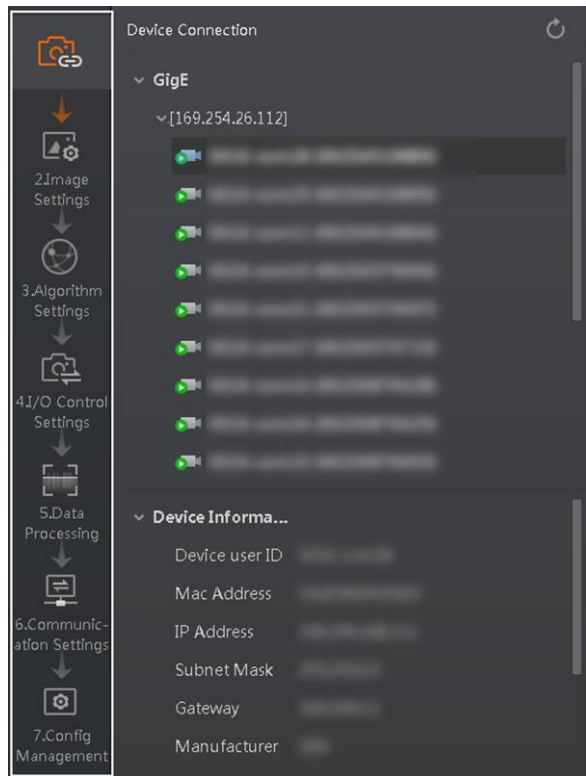
**Note**

The specific interfaces of the client software may differ by its versions.

Table 6-1 Description of Main Window

| No. | Name                           | Description  |
|-----|--------------------------------|--|
| 1   | Menu Bar                       | The menu bar displays function modules, including <b>Settings</b> , <b>Tool</b> , <b>View</b> , and <b>Help</b> .  |
| 2   | Control Toolbar                | The control toolbar provides quick operations for the device. You can click different icons to start or stop batch acquisition, change window layout, view statistics information, and device log. |
| 3   | Device Configuration Area      | You can connect or disconnect device, set parameters, and modify device IP address in this area.   |
| 4   | Live View Window               | This area displays the acquisition images and algorithm reading result in real-time. You can click different icons to capture and save image, record, etc.   |
| 5   | History Record and Image Cache | This area displays different code information read by the device in real-time. You can also set image cache here.  |

You can set device parameters in device configuration area.



**Figure 6-2 Device Configuration Area**

**Table 6-2 Configuration Area Description**

| No. | Module Name              | Description   |
|-----|--------------------------|---|
| 1   | Device Connection        | You can connect or disconnect device, modify device IP address, view device information, etc.   |
| 2   | Image Settings           | You can set image parameters, light parameters, etc.  |
| 3   | Algorithm Settings       | You can add different barcodes, set barcode number, etc.  |
| 4   | I/O Control Settings     | You can set parameters related with input and output.   |
| 5   | Data Processing          | You can set filter rule for output result.  |
| 6   | Communication Settings   | You can select different communication protocols, and set related parameters for output result. |
| 7   | Configuration Management | You can save and load user parameters, and restart the device.                                  |

## Chapter 7 Device Mode Settings

The device supports 3 types of operating modes, including **Test**, **Normal**, and **Raw**. You can select different modes in live view window according to actual demands.

### Note

- Stopping the real-time acquisition is required before selecting modes.
- You need to set device mode as **Normal** before specific device settings. Otherwise, the device parameters may be different.

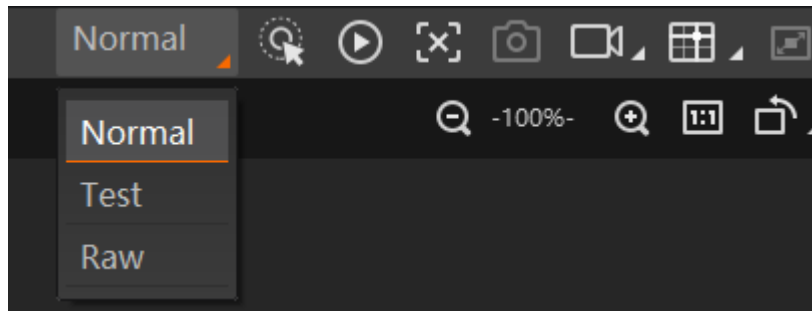



Figure 7-1 Select Device Mode

Table 7-1 Device Mode Description

| Device Mode | Description  |
|-------------|--|
| Test Mode   | It is used during device debugging. The device outputs images that are acquired in real-time, and displays code information. |
| Normal Mode | It is used during device normal operation. After reading code in image, the device outputs image and code information.       |
| Raw Mode    | It is used during testing image data. The device outputs raw data and displays code information.                             |

You can click  in the live view window to view images and the code reading effect. If the effect is not very good, you can adjust related parameters like exposure time, gain, Gamma, etc. in **Image Settings** area.



**Figure 7-2 Code Reading**

## Chapter 8 Device Settings

You are recommended to complete device settings in following order: **Device Connection** → **Image Settings** → **Algorithm Settings** → **I/O Control Settings** → **Data Processing** → **Communication Settings** → **Configuration Management**.

---

### Note

Before specific device settings, you need to set device mode as Normal. Otherwise, the device parameters may be different. Regarding device mode, refer to **Device Mode Settings** for details.

---

- **Device Connection:** It tells you how to connect the device to the client software. And you can configure and operate the device remotely via the client software only when you have connected the device to the client software. Refer to **Connect Device to Client Software** for details.
- **Image Settings:** It tells you how to set image related parameters of the device via client software. Refer to **Image Quality Settings** for details.
- **Algorithm Settings:** It tells you how to set the types of code to be read, the 1D code algorithm, the 2D code algorithm, etc. Refer to **Code Algorithm Settings** for details.
- **I/O Control Settings:** It tells you how to set the parameters related to the control of input and output signals of device. Refer to **Signal Input Settings** and **Signal Output Settings** for details.
- **Data Processing:** It tells you how to set filter rules for reading codes and other data processing related parameters. Refer to **Code Reading Result Settings** for details.
- **Communication Settings:** It tells you how to select different communication protocols, and set their corresponding parameters. Refer to **Communication Settings** for details.
- **Configuration Management:** It tells you how to set and manage the user parameters, restart device, etc. Refer to **User Set Customization** for details.

### 8.1 Image Quality Settings

This section introduces how to set image related parameters of the device via client software.

---

#### Note

For different models of the device, the specific parameters may differ, and the actual device you purchased shall prevail.

---

#### 8.1.1 Set Image

You can set different image parameters like exposure time, gain, Gamma, acquisition frame rate, acquisition burst frame count in image parameters interface.

### **Note**

- Make sure you have select the device to be set in **Device Connection** before setting image parameters.
  - For specific parameter range like exposure time, gain and acquisition frame rate, refer to the device's specification for details.
- 

### **Exposure Time**

You can increase exposure time to improve image brightness.

---

### **Note**

To some extent, increasing exposure time will reduce acquisition frame rate, and impact image quality.

---

### **Gain**

You can increase gain to improve image brightness.

---

### **Note**

To some extent, increasing gain will create more image noises, and impact image quality.

---

### **Gamma**

Gamma allows you to adjust the image contrast. It is recommended to reduce Gamma to increase brightness in dark background.

### **Acquisition Frame Rate**

Acquisition frame rate refers to the image number that is acquired by the device per second.

### **Acquisition Burst Frame Count**

Acquisition burst frame count refers to the outputted image number when the device is triggered once.

### **Polling Enable**

It enables the polling function, you can select off, single or multiple mode.

---

### **Note**

The parameter of polling enable will be displayed only when the trigger mode is on.

---

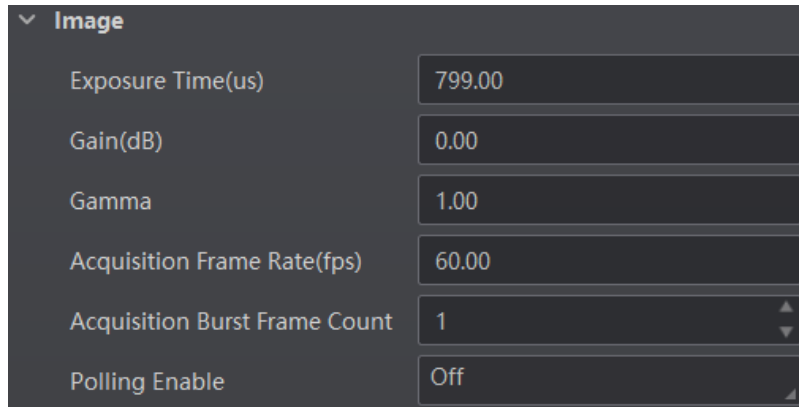


Figure 8-1 Set Image

### 8.1.2 Set Exposure

The device supports four types of exposure modes, including off, once, continuous, and alternate. Refer to the table below for details.

Table 8-1 Exposure Mode

| Exposure Mode | Description   |
|---------------|---|
| Off           | The device exposures according to the value configured by the user in <b>Exposure Time (μs)</b> .   |
| Once          | The device adjusts the exposure time automatically according to the image brightness. After adjusting once, the device will switch to off mode. |
| Continuous    | The device adjusts the exposure time continuously according to the image brightness.  |
| Alternate     | The device exposures alternately according to multiple groups of exposure time configured by the user.  |

### Once or Continuous Exposure

#### Steps

1. Right click the device in **Device Connection**, and click **Feature Tree**.
2. Go to **Image Setting**, and select **Once** or **Continuous** as **Exposure Auto** according to actual demands.
3. Select **Global** or **Partial** as **Exposing Area** according to actual demands.
4. (Optional) Set specific exposure area if **Partial** is selected.
  - Area Width: It refers to the horizontal resolution in partial exposure area.
  - Area Height: It refers to the vertical resolution in partial exposure area.
  - Offset X: It refers to the horizontal coordinate of the upper left corner in partial exposure area.
  - Offset Y: It refers to the vertical coordinate of the upper left corner in partial exposure area.

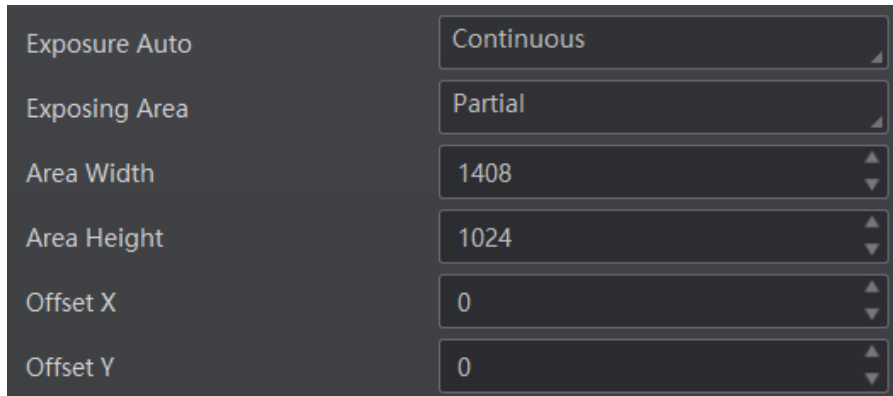


Figure 8-2 Once or Continuous Exposure

## Alternate Exposure

### Steps

1. Right click the device in **Device Connection**, and click **Feature Tree**.
2. Go to **Image Setting**, and enable **Exposure Alternate**.
3. Select one exposure parameter from **Exposure Index**.
4. Enable **Exposure Enable** and enter **Exposure Time** according to actual demands.
5. Repeat step 3 and step 4 to set multiple exposure parameters according to actual demands.

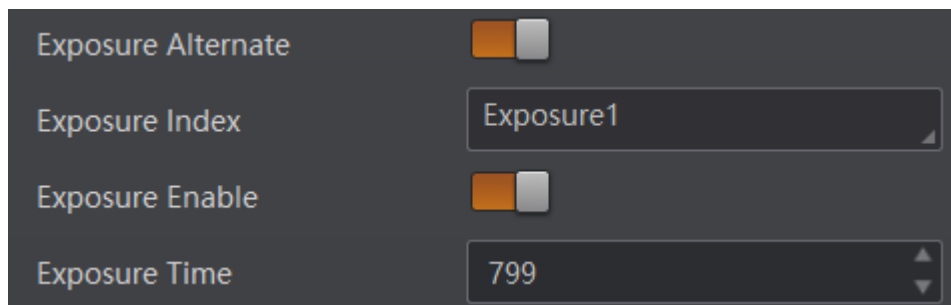


Figure 8-3 Alternate Exposure

---

### Note

The alternate exposure parameter may differ by device firmware versions and models.

---

## 8.1.3 Set Gain

The device supports four types of gain modes, including off, once, continuous, and alternate. Refer to the table below for details.

Table 8-2 Gain Mode

| Gain Mode  | Description  |
|------------|--|
| Off        | The device adjust gain according to the value configured by the user in <b>Gain (dB)</b> .   |
| Once       | The device adjusts gain automatically according to the image brightness. After adjusting once, the device will switch to off mode. |
| Continuous | The device adjusts gain continuously according to the image brightness.  |
| Alternate  | The device adjusts gain alternately according to multiple groups of gain configured by the user.                                   |

## Once or Continuous Gain

### Steps

1. Right click the device in **Device Connection**, and click **Feature Tree**.
2. Go to **Image Setting**, and select **Once** or **Continuous** as **Gain Auto** according to actual demands.

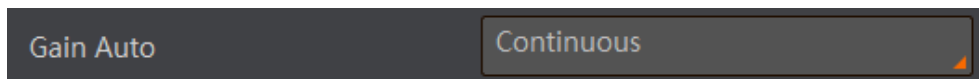


Figure 8-4 Once or Continuous Gain

## Alternate Gain

### Steps

1. Right click the device in **Device Connection**, and click **Feature Tree**.
2. Go to **Image Setting**, and enable **Gain Alternate**.
3. Select one gain parameter from **Gain Index**.
4. Enable **Gain Enable** and enter **Alternate Gain**.
5. Repeat step 3 and step 4 to set multiple gain parameters according to actual demands.

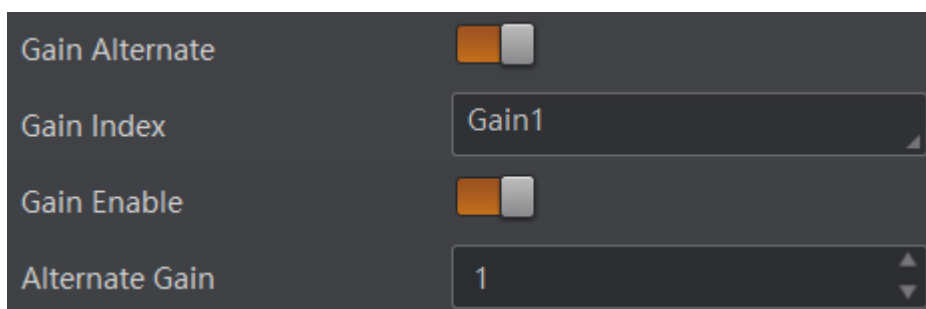


Figure 8-5 Alternate Gain

### Note

The alternate gain parameter may differ by device firmware versions and models.

## 8.1.4 Set Polling

The polling function allows the device to acquire images based on the parameters you set, including exposure time, gain, Gamma, and light source. Currently, 2 types of polling modes are available, including single mode and multiple mode.

### Single Mode

#### Note

- Stopping the real-time acquisition is required before setting the polling function.
- After the polling enabled, the device acquires images with its max. frame rate. Once the polling disabled, the frame rate you set in **Acquisition Frame Rate** takes effect.
- The polling function may differ by device models.

#### Steps

1. Go to **Image Settings** → **Image** → **Polling Enable**, and select **Single** as **Polling Enable**.
2. Select one parameter (e.g. **Param1**) from **Polling Param**.
3. Set **Polling Exposure Time**, **Polling Gain**, and **Polling Gamma** according to actual demands
4. Select **Polling Light Selector** according to actual demands, and enable **Polling Light Enable**.

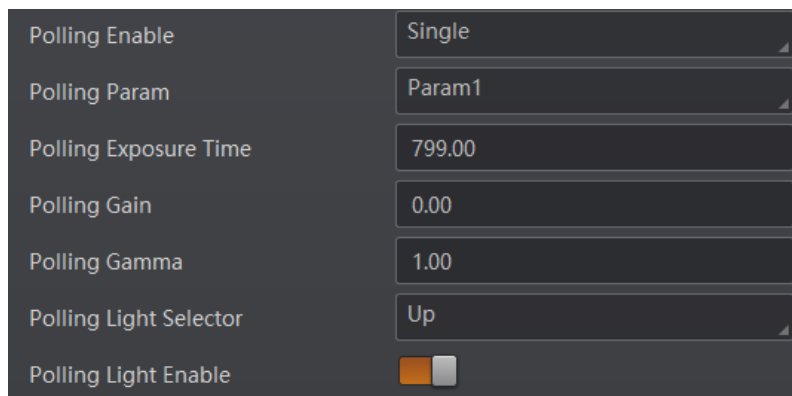


Figure 8-6 Single Mode

### Multiple Mode

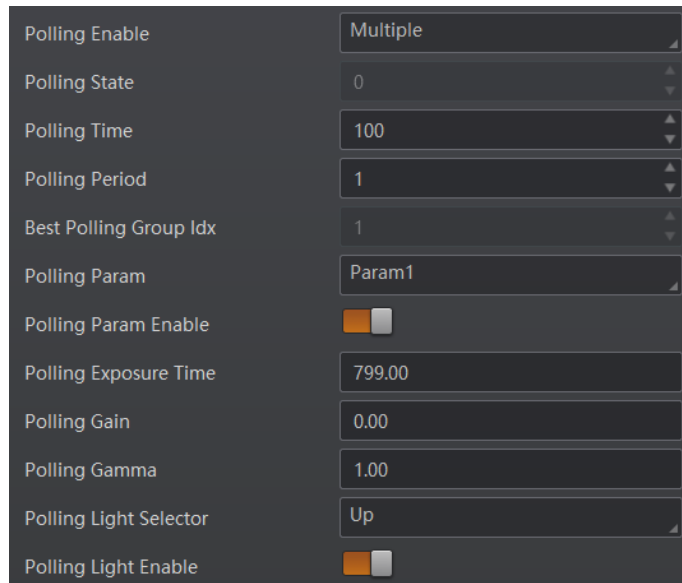
#### Note

- The parameter of Best Polling Group Idx is used to display the polling parameter number when the device recognizes codes after enabling polling. If the polling is disabled or polling parameters are edited, it displays 1 by default.
- The rule for multiple-mode polling is that the polling is started from the polling parameter with Best Polling Group Idx, and then execute other polling parameters you selected in turn. For example, if the Param3 is the Best Polling Group Idx and Param1, Param2, Param4 and Param5

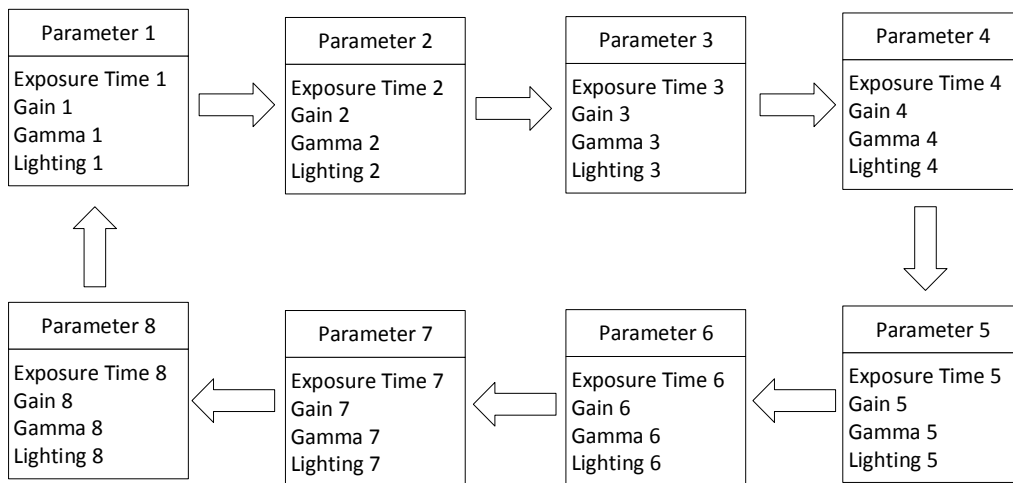
are enabled, the polling order is Param3 > Param1 > Param2 > Param4 > Param5.

**Steps**

1. Go to **Image Settings** → **Image** → **Polling Enable**, and select **Multiple** as **Polling Enable**.
2. Set **Polling Time** and **Polling Period** according to actual demands.
3. Select 2 to 8 sets of parameters (e.g. **Param1** and **Param2**) from **Polling Param**, and enable **Polling Param Enable** to let them take effect.
4. Set **Polling Exposure Time**, **Polling Gain**, and **Polling Gamma** for the **Polling Param** you selected.
5. Select **Polling Light Selector** according to actual demands, and enable **Polling Light Enable**.
6. Repeat step 3 to step 5 to set other parameters from **Polling Param**.



**Figure 8-7 Multiple Mode**



**Figure 8-8 Polling Diagram**

### 8.1.5 Set Light Source

You can select different light types, and set their related parameters in the light interface.

---

#### Note

- Light source parameters may differ by device models.
  - Make sure you have selected the device to be set in **Device Connection** before setting light source parameters.
- 

You can select different light sources in **Light Type**.

#### **Own Lighting**

It refers to use the device's embedded light source to light during code reading.

#### **External Lighting**

It refers to the device controls the external light source by triggering output signal during code reading.

#### **Non-Lighting**

It refers to the device turns off light source during code reading.

---

#### Note

If you select **Non-Lighting** as **Light Type**, you do not need to set any parameters.

---

### Set Own Lighting

If you select **Own Lighting** as **Light Type**, you can set the following parameters.

#### **Aiming Light Enable**

You can enable **Aiming Light Enable** to enable the device's aiming light.

---

#### Note

The parameter of aiming light enable may differ by device model.

---

#### **Lighting Selector**

You can click lamps on the light source illustration to turn on or turn off lamps on different directions.

---

#### Note

The specific lighting selector may differ by device model. For devices with 4 groups of lamps, you can check **All** to turn on all lamps. For devices with 6 groups of lamps, you can click **All On** or **All Off** to turn on or turn off all lamps.

---

#### **Light Mode**

It has 2 light modes, including **Flash Strobe** and **Flash Long**. **Flash Strobe** means the light flashes

---

at a specific interval during code reading, and **Flash Long** means the light is solid during code reading.

### Lighting Duration

It sets the lighting duration and the unit is  $\mu\text{s}$ .

### Lighting Delay Time

---

#### Note

This parameter is available only when you set **Flash Strobe** as the **Light Mode**.

---

It determines the delay time for lighting after exposure and the unit is  $\mu\text{s}$ .

### Precharge Time

It determines how earlier the light source starts lighting before exposure and the unit is  $\mu\text{s}$ .

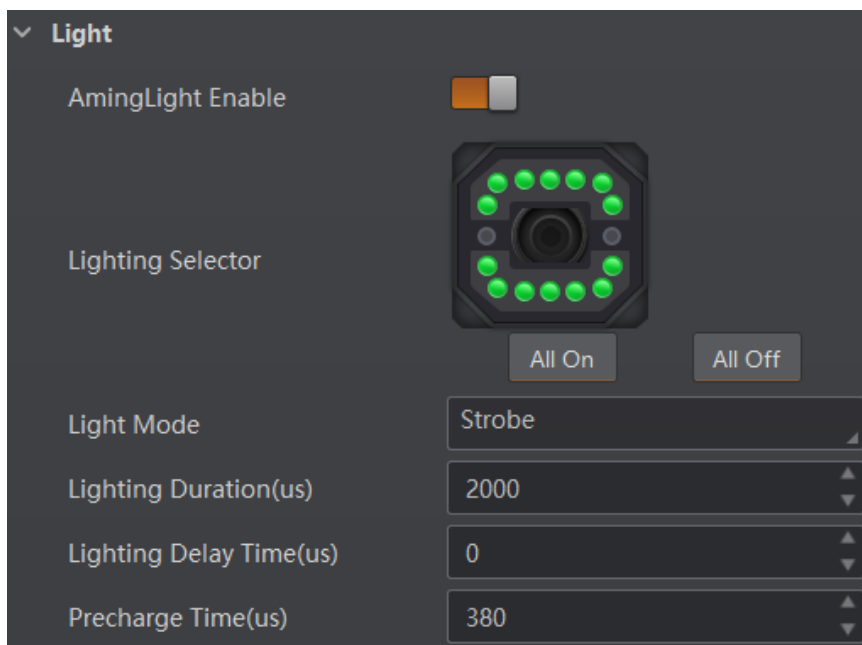


Figure 8-9 Light Parameters

---

#### Note

The figure above is only for reference. The specific graphic user interface may differ by device models.

---

## Set External Lighting

If you select **External Lighting** as **Light Type**, you can set the following parameters.

### Line Out Duration

The lighting duration of the external light source and the unit is  $\mu\text{s}$ .

### Line Out Delay Time

It sets the delay time for lighting after device outputs event source, and the unit is  $\mu\text{s}$ .

### Line Out Ahead Time

It sets how earlier the external light starts lighting before the device outputs event source information, and the unit is  $\mu\text{s}$ .

## 8.1.6 Set Lens Focus


The device supports setting lens focus via the client software. 2 ways are available to set lens focus, including auto focus and manual focus.

### Note

- The lens focus function may differ by device models.
- Setting the device mode as **Test** is required before setting lens focus. After completion, you can set the device mode as **Normal**.
- Setting the trigger mode as off is required before setting lens focus.

## Auto Focus

### Steps

1. Click  in the live view window.
2. Go to **Image Settings** → **Auto Focus**, and click **Execute** in **Focus Mode**.  
The device starts to adjust focus automatically.
3. Select the position parameter from **Focus Position**, and click **Execute** in **Focus Position Save** to save the focus position.
4. (Optional) Select the position parameter from **Focus Position**, and click **Execute** in **Focus Position Load** to load saved focus position.

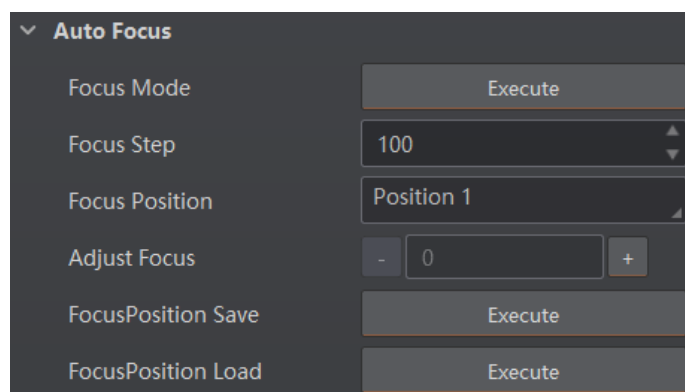


Figure 8-10 Auto Focus

## Manual Focus

1. Go to **Image Settings** → **Auto Focus**, and set **Focus Step** according to actual demands.
2. Click **-** or **+** in **Adjust Focus** to adjust focus.
3. Select the position parameter from **Focus Position**, and click **Execute** in **Focus Position Save** to save the focus position.
4. (Optional) Select the position parameter from **Focus Position**, and click **Execute** in **Focus Position Load** to load saved focus position.

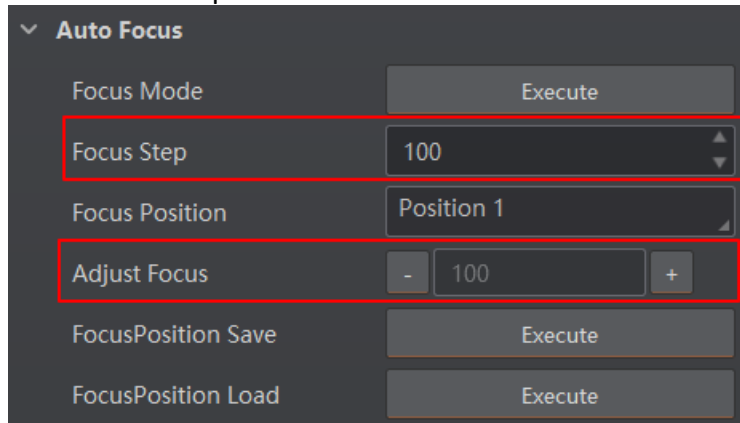


Figure 8-11 Manual Focus

### 8.1.7 Set Self-Adaptive Adjustment

#### Note

This function may differ by device models.

The function of self-adaptive adjustment can automatically adjust exposure, gain, Gamma and other parameters to have a better code reading effect.

#### Steps

1. Right click the device in **Device Connection**, and click **Feature Tree**.
2. Go to **Self Adapt Adjust**, and select **Adjust Mode**.
  - High Quality: In this mode, the client software will adjust exposure in priority with small gain and noise. The image quality is high, and this mode is applicable to the scenario for low speed conveyer belt.
  - High Speed: In this mode, the client software will adjust gain in priority with small exposure and large gain. The image quality is less high, and this mode is applicable to the scenario for high speed conveyer belt.
3. Select **Param Source** according to actual demands.
  - Default Param: It adjusts the default parameters.
  - Polling Param: It adjusts parameters configured in polling.

4. (Optional) Enable or disable **Lighting Adapt** during self-adaptive adjustment. If it is enabled, the client software will select the best one from all lighting options during the self-adaptive adjustment. If it is disabled, the client software will keep the lighting status before the self-adaptive adjustment.
5. (Optional) Set **Gain Max** or **Exposure Max** according to actual demands.
  - Gain Max: It is enabled in high quality mode, and it sets the max. gain during the self-adaptive adjustment.
  - Exposure Max: It is enabled in high speed mode, and it sets the max. exposure during the self-adaptive adjustment.
6. (Optional) You can set **Adjust Timeout** to set the duration of the self-adaptive adjustment, and the adjustment will stop if the duration is exceeded. The unit of **Adjust Timeout** is second.
7. Click **Execute** in **Adjust Start**. The device will automatically acquire images and perform self-adaptive adjustment, and stop acquisition after adjustment is completed.

---

**Note**

If the adjustment completed, the client software displays the spent time and prompts adjustment succeeded. If the adjustment failed or is timeout, the client software prompts adjustment failure or timeout.

---

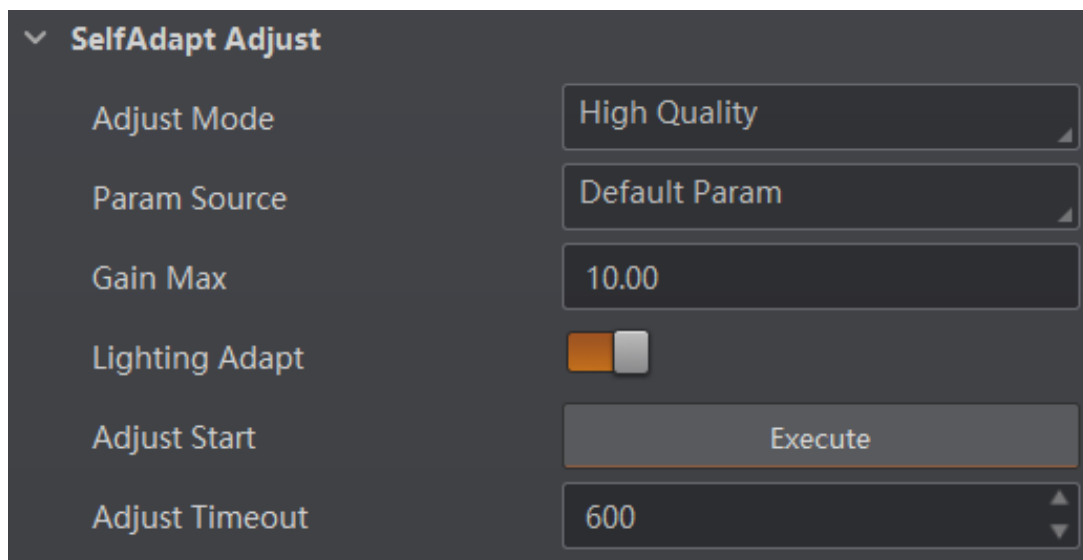


Figure 8-12 Set Self-Adaptive Adjustment

### 8.1.8 Set Mirror X

The device supports the mirror X function. If this function is enabled, the image will be reversed in a horizontal way.

Go to **Image Settings**, click **All Features**, and you can see the **Mirror X**.

---

**Note**

This function is enabled by default, and it may differ by device models.

---

### 8.1.9 Set Test Pattern

Test pattern helps troubleshooting image problems and images in the test pattern are only for test. When exceptions occur in images acquired by the device in real time, you can check if images in the test pattern have similar problems to determine the cause of an exception.

---

#### Note

- The test pattern is available in the test or raw device mode.
  - Specific parameters of this function may differ by device models.
- 

Go to **Image Settings**, click **All Features**, find **Test Pattern** in **Other Features**, and set **Test Pattern** according to actual demands.

## 8.2 Code Algorithm Settings

The code reader supports reading multiple types of 1D code and 2D code, and you can add and set code parameters via the client software.

### 8.2.1 Add Code

Adding code before you set code parameters via the client software. In **Algorithm Settings**, you can add different types of codes according to actual demands.

In **Algorithm Settings**, click **Add Barcode**, select the types of codes to be read, and set the **1D Code Number** and **2D Code Number** according to actual demands.

---

#### Note

- For different models of the device, the specific parameters may differ, and the actual device you purchased shall prevail.
  - Selected symbology amount and added code amount may affect the code recognition time. Note that selecting more symbologies or adding more codes may consume more time to recognize codes in the image.
  - No matter 1D code or 2D code, up to 20 codes can be added at a time. Note that adding more codes may consume more time to recognize codes in the image. Therefore, the code number is recommended to be set according to the actual demands.
  - The code reader may output actual code number when the mismatch between the actual code number and the code number set in the client software occurs.
-

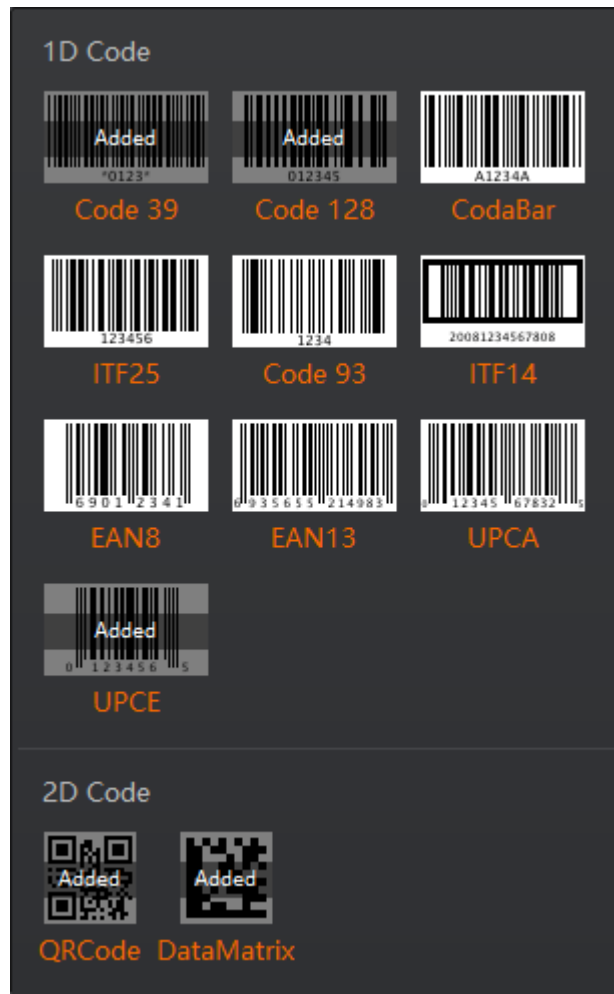


Figure 8-13 Add Codes

## 8.2.2 Set Code Reading ROI

Algorithm ROI (Region of Interest) allows the device to execute algorithms and read codes on the specific area you selected, and thus improving code reading efficiency.

Currently, up to 4 ROIs can be configured, and the device outputs codes according to the number of ROI (e.g. Region 1, Region 2, and Region 3) in turn. The client software supports drawing single group of ROI, drawing ROI in batch, and drawing ROI via chessboard.

### Note

- If no code is recognized in the algorithm ROI, and the device will output “noread”.
- Before drawing ROIs, make sure that there are images in the live view window after stopping preview.
- If no algorithm ROI is enabled, and the full screen is the algorithm ROI by default.
- This function may differ by device models.

## Draw Single Group of ROI

### Steps

1. Go to **Algorithm Settings**, click **All Features**, and find **Algorithm ROI**.
  2. Click **Draw** to draw ROI in the live view window.
  3. (Optional) Repeat the above step to draw multiple ROIs according to actual demands.
- 

### Note

The client software only parse codes in the ROI you drawn.

---

4. (Optional) Set other ROI parameters according to actual demands.
    - ROI Index: It indicates different ROIs and ranges from 0 to 149 which corresponds 1 to 150 ROIs.
    - Draw ROI Width: It refers to the width in algorithm ROI.
    - Draw ROI Height: It refers to the height in algorithm ROI.
    - Draw ROI Offset X: It refers to the X coordinate of the upper left corner in algorithm ROI.
    - Draw ROI Offset Y: It refers to the Y coordinate of the upper left corner in algorithm ROI.
- 

### Note

The result of Draw ROI Width plus Draw ROI Offset X cannot be larger than the overall horizontal resolution, and the result of Draw ROI Height plus Draw ROI Offset Y cannot be larger than the overall vertical resolution.

---

5. (Optional) Click **Execute** in **Restore Max. Algorithm ROI** to restore the ROI to the full screen.
  6. (Optional) Click **Execute** in **Clear All ROI** to delete all ROIs.
  7. (Optional) Enable **ROI Link IO Enable** in **Algorithm Control**, and there will be prompts by the output device when codes are not read in any ROI.
- 

### Note

Make sure that the output device is connected when using this function.

---

## Draw ROI in Batch

### Steps

1. Go to **Algorithm Settings**, click **All Features**, and find **Algorithm ROI**.
  2. Click **Batch** to set parameters according to actual demands.
    - Area Offset: It sets the pixel quantity from the starting point when the ROI is in horizontal and vertical direction from the full resolution.
    - Area Size: It sets the pixel quantity in the horizontal and vertical direction of the ROI.
    - ROI Number: It sets the row and column quantity.
    - Row Spacing: It sets the interval between rows.
    - Column Spacing: It sets the interval between columns.
  3. Click **OK** after settings.
-

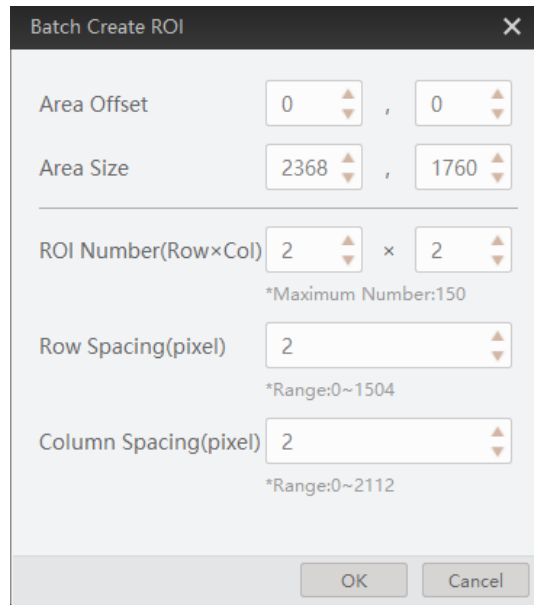
- Repeat other optional steps mentioned in drawing single group of ROI according to actual demands.
- (Optional) Enable **ROI Link IO Enable** in **Algorithm Control**, and there will be prompts by the output device when codes are not read in any ROI.

---

 **Note**

Make sure that the output device is connected when using this function.

---



**Figure 8-14 Draw ROI in Batch**

## Draw ROI via Chessboard

### Steps

- Go to **Algorithm Settings**, click **All Features**, and find **Algorithm ROI**.
- Click **Execute** in **Chessboard ROI**, set parameters according to actual demands, and click **OK** after setting.

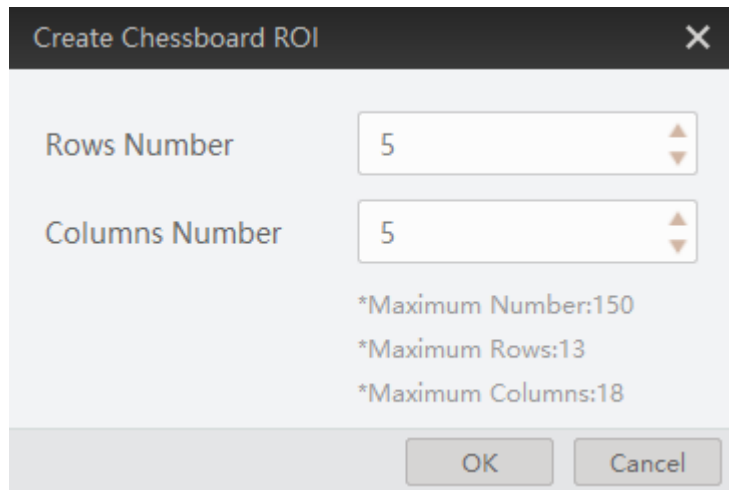


Figure 8-15 Create Chessboard ROI

3. Click  after creating ROI, and the red frame becomes green as shown below.

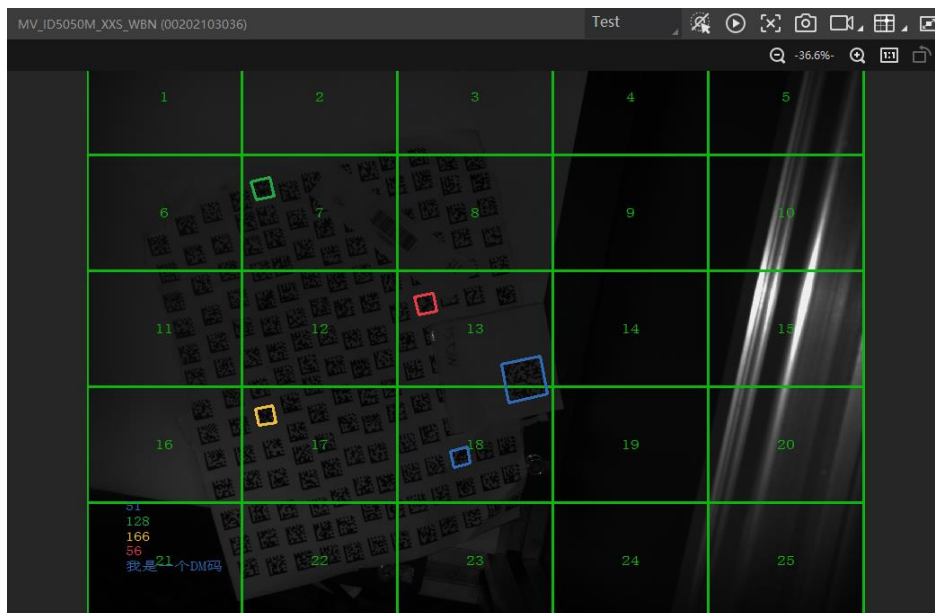


Figure 8-16 Draw ROI via Chessboard

4. (Optional) Click  to restore the ROI to the full screen, and click  to clean all configured ROIs.
5. Repeat other optional steps mentioned in drawing single group of ROI according to actual demands.
6. (Optional) Enable **ROI Link IO Enable** in **Algorithm Control**, and there will be prompts by the output device when codes are not read in any ROI.

#### Note

- Make sure that the output device is connected when using this function.
- The figures above are for reference only, and refer to the actual conditions.

### 8.2.3 Set 1D Algorithm Parameter

Click **All Features** on the upper-right to display all algorithm parameters. In the **Algorithm Parameter** page, select **1D Code** as **Arithmetic Type**, and then you can set its corresponding parameters.

---

#### Note

- You should have selected at least one type of 1D code.
  - For different models of the device, the specific parameters may differ, and the actual device you purchased shall prevail.
- 

#### Timeout Value

Timeout value refers to the maximum running time of algorithm, and its unit is ms. The code reader will stop parsing the images and return results if the time is exceeded the waiting time configured.

#### Code Color

It defines the readable code color. **White Code On Black Wall** means that the client software can recognize the white code with black background. **Black Code On White Wall** means that the client software can recognize the black code with white background.

#### Code 39 Check

Enable this parameter if Code 39 uses the parity bit.

---

#### Note

You need to select **Code 39** in **Add Barcode**.

---

#### ITF 25 Check

Enable this parameter if ITF 25 uses the parity bit.

---

#### Note

You need to select **ITF 25** in **Add Barcode**.

---

#### Code Score Enable

If it is enabled, the device will evaluate code quality and display overall grade and code score in history record area of the client software. The higher the score, and the better the code quality.

#### Accurate Timeout Enable

If it is enabled, the accuracy of algorithm timeout will improve.

### 8.2.4 Set 2D Algorithm Parameter

Click **All Features** on the upper-right to display all algorithm parameters. In the **Algorithm Parameter** page, select **2D Code** as **Arithmetic Type**, and then you can set its corresponding

---

parameters.

---

### Note

- You should have selected at least one type of 2D code.
  - For different models of the device, the specific parameters may differ, and the actual device you purchased shall prevail.
- 

### Timeout Value

Timeout value refers to the maximum running time of algorithm, and its unit is ms. The code reader will stop parsing the images and return results if the time is exceeded the waiting time configured.

### Algorithm Running Mode

It is used to be set the algorithm operating mode. It includes **High Speed**, **High Performance**, and **Balance**. **High Speed** focuses on recognition speed, and the algorithm can recognize the code rapidly, while **High Performance** refers to the algorithm can recognize the code that has distortion, spot or white gap, but its recognition speed is slow. **Balance** refers to the algorithm makes a balance between speed and performance.

### 2D Code Max. Size

It refers to the max. recognizable code width. The 2D code will not be recognized if its width exceeds the configured value.

### Mirror Mode

It is useful when the recognized image is a mirror one, mirroring in X coordinate. 3 modes are available: **Adaptive**, **Mirror**, and **Non Mirror**.

### Downsampling Level

It refers to the pixel sample size that the code reader takes. Increasing this parameter will improve the code reading efficiency at the expense of code recognition rate.

---

### Note

Increasing this parameter value will improve the code reading efficiency at the cost of code recognition rate.

---

### Code Color

It defines the readable code color. **Adaptive** means that the client software can recognize both the black code with white background, and the white code with black background. **White Code On Black Wall** means that the client software can recognize the white code with black background. **Black Code On White Wall** means that the client software can recognize the black code with white background.

---

### Note



- For QR code, the code color is determined by the color of the concentric square on it.  indicates that the code color is white, and  indicates that the code color is black.



Figure 8-17 White QR Code



Figure 8-18 Black QR Code

- For DM code, the code color is determined by the color of its "L" shaped sides. White "L" shaped sides indicate that the code color is white, and black "L" shaped sides indicate that the code color is black.





Figure 8-19 White DM Code





Figure 8-20 Black DM Code

---

#### Discrete Flag

**Continuous** stands for the minimum units in the "L" shaped sides of the DM code are continuous, or the minimum units in the concentric square like  or  in the QR code are

continuous. Usually the continuous code uses squares as the minimum units.

**Discrete** stands for the minimum units in the "L" shaped sides of the DM code are discrete, or the minimum units in the concentric square like  or  in the QR code are discrete. Usually the discrete code uses dots as the minimum units.

**Adaptive** stands for the device can recognize both continuous code and the discrete code.

### QR Distortion Correction

If the QR code or DM code is distorted, you can enable this parameter to improve code recognition rate.



If you enable this parameter, the more time will be consumed to recognize the codes in the image.

---

### Advance Param

This parameter is applicable to some special codes, and it is recommended to use the default value.

### DM Code Shape

It defines the recognizable code shape. **Square** stands for square mode: If the 2D code is square shaped, it can be recognized by the device. **Rectangle** stands for rectangle mode: If the 2D code is rectangle shaped, it can be recognized by the device. **Adaptive** stands for compatible mode: The device can recognize 2D codes of both the above-mentioned two shapes.

### DM Code Type

It includes **All**, **ECC140**, and **ECC200**.

### 2D Code Quality Enable

Refer to section *Set 2D Code Quality Evaluation* for details.

### Code Score Enable

If it is enabled, the device will evaluate code quality and display overall grade and code score in history record area of the client software. The higher the score, and the better the code quality.

### Accurate Timeout Enable

If it is enabled, the accuracy of algorithm timeout will improve.

## 8.2.5 Set 2D Code Quality Evaluation

After **2D Code Quality Enable**, you can set specific parameters according to actual demands.




- The function of code quality evaluation may differ by device models.
  - In test mode, this function is enabled by default. In normal mode, you need to enable it manually.
-

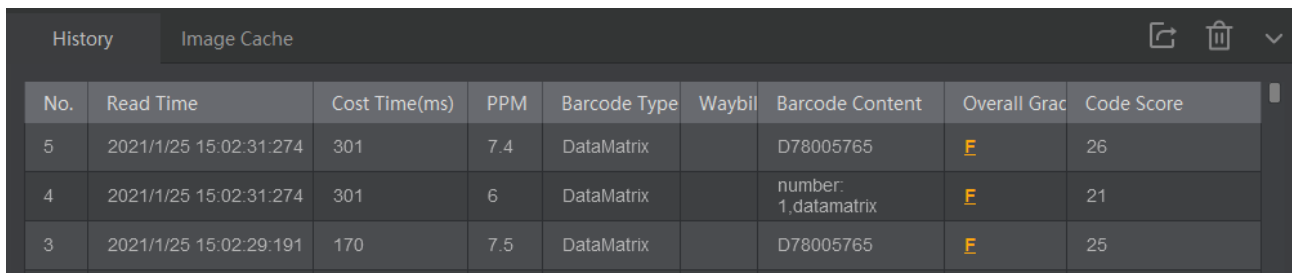
**Steps**

1. Set **Sym Proc Type** according to actual demands, and the default type is **Type 1**. Type 1 has a strong capacity to locate codes.
2. Set **Iso Edition**, including Iso15415 and Iso29158
  - Iso15415 is applicable to the quality evaluation for label 2-dimensional codes.
  - Iso29158 is applicable to the quality evaluation for DPM format 2-dimensional codes.
3. Set **Verify Edition**, including standard mode and HIK mode.
  - Standard mode is a standard quality evaluation mode.
  - HIK mode is a professional quality evaluation mode.
4. Set **Standard Aperture** and **Magnification**.
  - Standard aperture refers to a standard aperture, and its default value is 400.
  - Magnification is 150 by default.

 **Note**

**Standard Aperture** and **Magnification** should be configured only when **Type 2** is selected as **Sym Proc Type**.

5. Click  to start acquisition, and the client software will display the overall code quality in the history area.



| No. | Read Time              | Cost Time(ms) | PPM | Barcode Type | Waybil | Barcode Content      | Overall Grad | Code Score |
|-----|------------------------|---------------|-----|--------------|--------|----------------------|--------------|------------|
| 5   | 2021/1/25 15:02:31:274 | 301           | 7.4 | DataMatrix   |        | D78005765            | F            | 26         |
| 4   | 2021/1/25 15:02:31:274 | 301           | 6   | DataMatrix   |        | number: 1,datamatrix | F            | 21         |
| 3   | 2021/1/25 15:02:29:191 | 170           | 7.5 | DataMatrix   |        | D78005765            | F            | 25         |

**Figure 8-21 2D Code Quality Evaluation**

 **Note**

The overall grade includes A, B, C, D and F. A means that the code quality is the best while F means that the code quality is the worst.

6. (Optional) Click specific grade in the overall grade list to view different quantity evaluation items.

**8.2.6 Set Code Score**

After enabling code score function, the client software can output specific score for codes it has read.

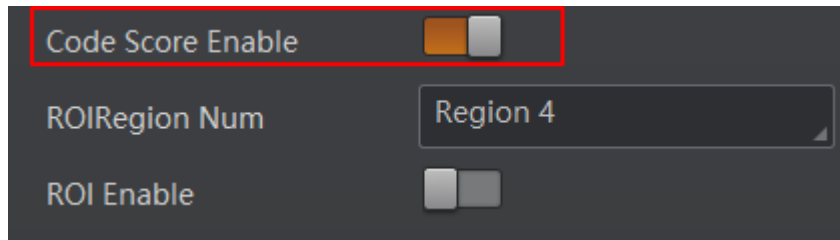
 **Note**

- The function of code score may differ by device models.
- In test mode, this function is enabled by default. In normal mode, you need to enable it manually.


- The code score is determined by two factors including image quality and print quality of codes. The range of code score is between 0 and 100, and the higher the score, and easier the code can be read.

**Steps**

1. Right click the device in **Device Connection**, and click **Feature Tree**.
2. Go to **Algorithm Control**, and enable **Code Score Enable**.



**Figure 8-22 Enable Code Score**

3. Click  to start acquisition, and the client software will display specific code score in the history area.

| No. | Read Time              | Cost Time(ms) | PPM | Barcode Type | Waybil | Barcode Content      | Overall Grac | Code Score |
|-----|------------------------|---------------|-----|--------------|--------|----------------------|--------------|------------|
| 5   | 2021/1/25 15:02:31:274 | 301           | 7.4 | DataMatrix   |        | D78005765            | E            | 26         |
| 4   | 2021/1/25 15:02:31:274 | 301           | 6   | DataMatrix   |        | number: 1,datamatrix | E            | 21         |
| 3   | 2021/1/25 15:02:29:191 | 170           | 7.5 | DataMatrix   |        | D78005765            | E            | 25         |

**Figure 8-23 Code Score**

4. (Optional) Go to **Image Settings**, and adjust parameters like exposure time, gain, Gamma, light source, etc. if the code score is low.

 **Note**

If the code score is still low after adjusting, and the code may have poor printing quality.

## 8.3 Signal Input Settings

In the signal input module, you can set the trigger related parameters. You can enable trigger mode to let the acquisition of image data occur only when the trigger source is generated.

### 8.3.1 Set Trigger Mode

The device has 2 types of trigger modes, including internal trigger mode and external trigger

mode.

### Internal Trigger Mode

In this mode, the device acquires images via its internal signals.

### External Trigger Mode

In this mode, the device acquires images via external signals like software signal and hardware signal. The trigger source of external trigger mode includes software, physical lines, counter, TCP, UDP, serial port and self trigger.




#### Note

The specific external trigger mode may differ by device models.

---


## 8.3.2 Enable Internal Trigger Mode

In the internal trigger mode, the device acquires images via its internal signals. You have 2 methods to enable the internal trigger mode:

- Click **I/O Control Settings** → **Input** → **Trigger Mode**, and select **Off** as **Trigger Mode**.
- In the live view page, click  to enable the internal trigger mode.

## 8.3.3 Enable External Trigger Mode

In the external trigger mode, the device acquires images via external signals like software signal and hardware signal. You have 2 methods to enable the external trigger mode:

- Click **I/O Control Settings** → **Input** → **Trigger Mode**, and select **On** as **Trigger Mode**.
- In the live view page, click  to enable the external trigger mode.

## Set and Execute Software Trigger Mode

In software trigger, the software sends trigger signal to the device via I/O interface to acquire images.

### Steps

1. Click **I/O Control Settings** → **Input** → **Trigger Mode**.
2. Select **On** as **Trigger Mode**.
3. Select **Software** as **Trigger Source**.
4. Click **Execute** in **Trigger Source** to send trigger commands.

You can also enter **Auto Trigger Time**, and then enable **Enable Auto Trigger** to let the client software automatically send trigger signal to device according to the interval you set.

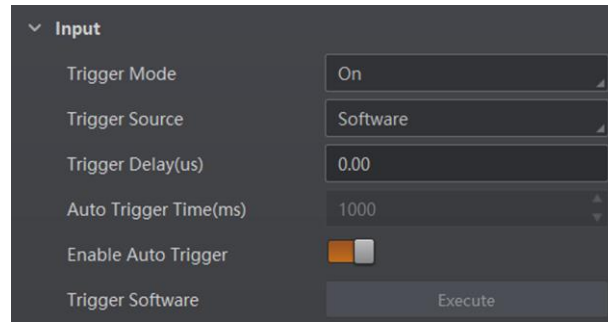


Figure 8-24 Set and Execute Software Trigger Mode

### Steps

1. Click **I/O Control Settings** → **Input** → **Trigger Mode**.
2. Select **On** as **Trigger Mode**.
3. Select the specific line as **Trigger Source** according to actual demands.
4. Set **Debounce Time** and **Line Out Trigger In Polarity** according to actual demands.

### Note

- When selecting **Rising Edge** or **Falling Edge** as **Line Out Trigger In Polarity**, you can set **Trigger Delay**.
- When selecting **Level High** or **Level Low** as **Line Out Trigger In Polarity**, you can set **Start Delay Time** and **End Delay Time** according to actual demands.

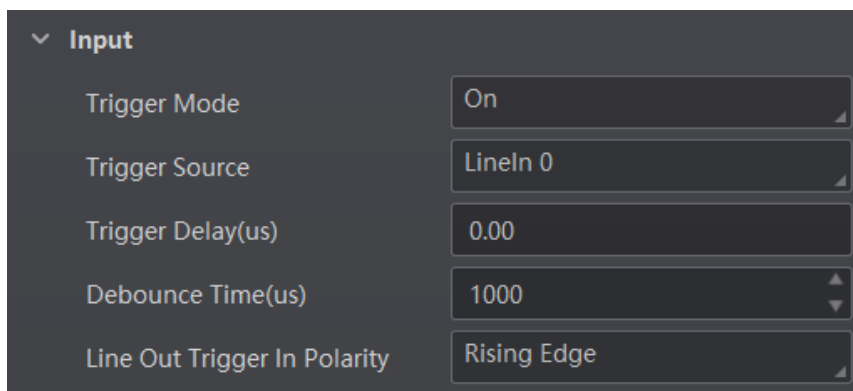


Figure 8-25 Set and Execute Hardware Trigger Mode

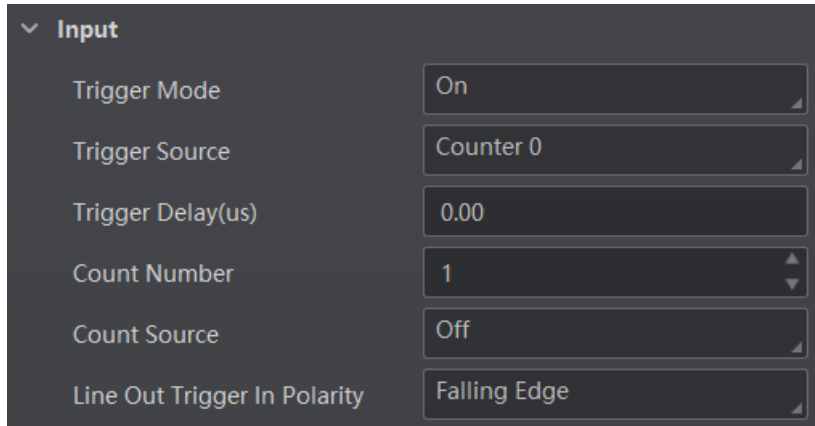
### Set and Execute Counter Trigger Mode

Counter specifies that the trigger source will be generated after the set number of valid signals appears. For example, if you set the **Count Number** to **3**, the trigger source will be generated after 3 signals appear.

### Steps

1. Click **I/O Control Settings** → **Input** → **Trigger Mode**.
2. Select **On** as **Trigger Mode**.

3. Select **Counter 0** as **Trigger Source**.
4. Set **Trigger Delay**, **Count Number**, **Count Source** and **Line Out Trigger In Polarity** according to actual demands.



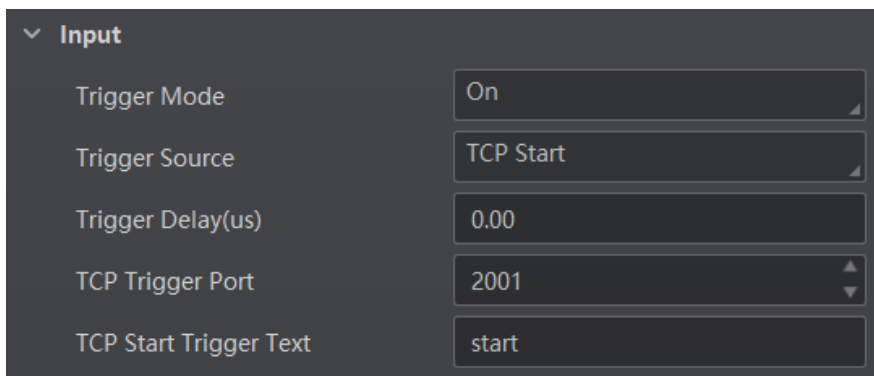
**Figure 8-26 Set and Execute Counter Trigger Mode**

### Set and Execute TCP Trigger Mode

TCP start specifies the TCP server as the source for the trigger signal. When the server receives the specified string text, the trigger signal will be outputted.

#### Steps

1. Click **I/O Control Settings** → **Input** → **Trigger Mode**.
2. Select **On** as **Trigger Mode**.
3. Select **TCP Start** as **Trigger Source**.
4. Set **Trigger Delay**, **TCP Trigger Port**, and **TCP Start Trigger Text** according to actual demands.



**Figure 8-27 Set and Execute TCP Trigger Mode**

### Set and Execute UDP Trigger Mode

UDP start specifies the UDP server as the source for the trigger signal. When the server receives

the specified string text, the trigger signal will be outputted.

### Steps

1. Click **I/O Control Settings** → **Input** → **Trigger Mode**.
2. Select **On** as **Trigger Mode**.
3. Select **UDP Start** as **Trigger Source**.
4. Set **Trigger Delay**, **UDP Trigger Port**, and **UDP Start Trigger Text** according to actual demands.

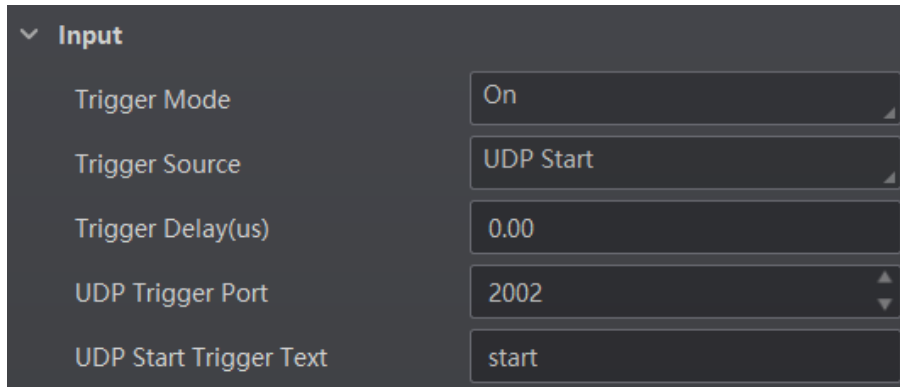


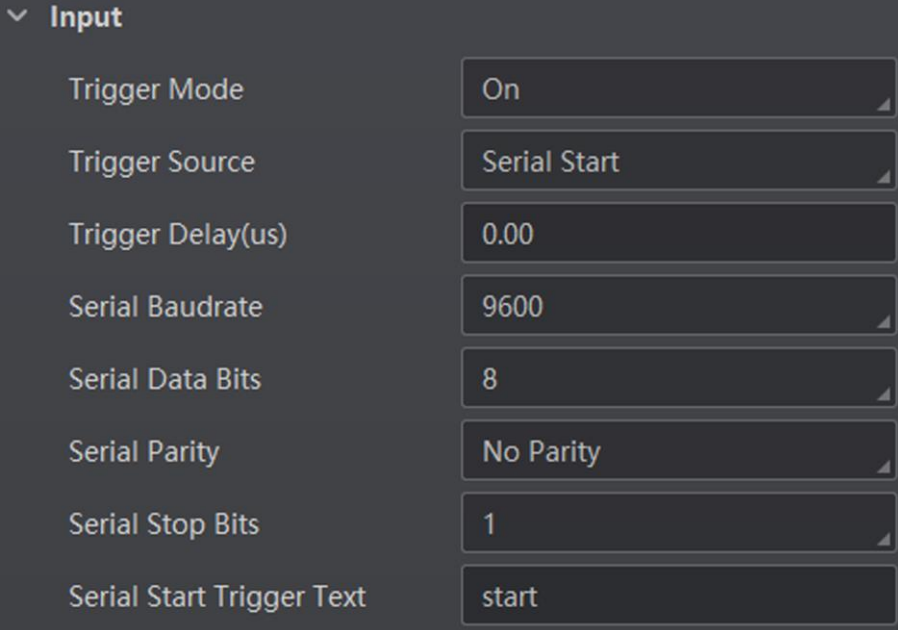
Figure 8-28 Set and Execute UDP Trigger Mode

### Set and Execute Serial Port Trigger Mode

Serial start specifies the serial port as the source for the trigger signal. When the serial port receives the specified string text, the trigger signal will be outputted.

### Steps

1. Click **I/O Control Settings** → **Input** → **Trigger Mode**.
2. Select **On** as **Trigger Mode**.
3. Select **Serial Start** as **Trigger Source**.
4. Set **Trigger Delay**, **Serial Baud Rate**, **Serial Data Bits**, **Serial Parity**, **Serial Stop Bits**, and **Serial Start Trigger Text** according to actual demands.



The screenshot shows a dark-themed settings menu with a dropdown arrow on the left labeled 'Input'. The settings are as follows:

| Setting                   | Value        |
|---------------------------|--------------|
| Trigger Mode              | On           |
| Trigger Source            | Serial Start |
| Trigger Delay(us)         | 0.00         |
| Serial Baudrate           | 9600         |
| Serial Data Bits          | 8            |
| Serial Parity             | No Parity    |
| Serial Stop Bits          | 1            |
| Serial Start Trigger Text | start        |

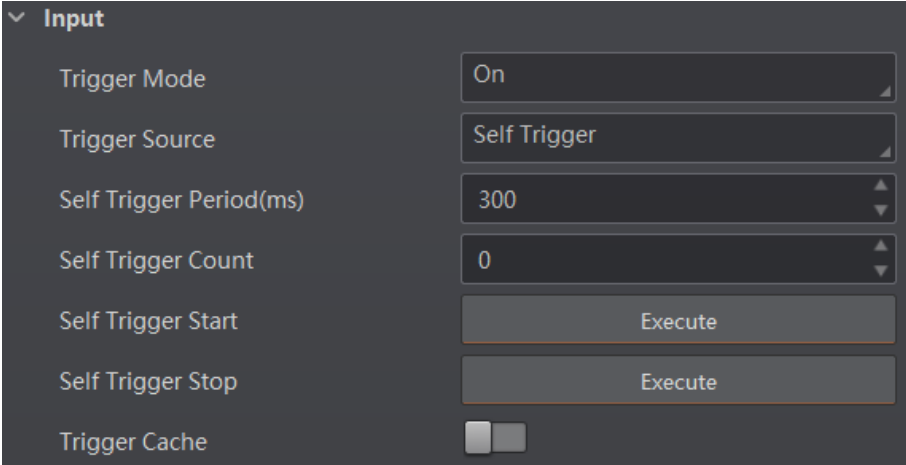
Figure 8-29 Set and Execute Serial Port Trigger Mode

### Set and Execute Self Trigger Mode

Self trigger mode allows you to trigger the device according to the trigger period you configured.

#### Steps

1. Click **I/O Control Settings** → **Input** → **Trigger Mode**.
2. Select **On** as **Trigger Mode**.
3. Select **Self Trigger** as **Trigger Source**, and set **Self Trigger Period** and **Self Trigger Count**.
4. Click **Execute** in **Self Trigger Start** to start, and click **Execute** in **Self Trigger Stop** to stop.



The screenshot shows a dark-themed settings menu with a dropdown arrow on the left labeled 'Input'. The settings are as follows:

| Setting                 | Value                    |
|-------------------------|--------------------------|
| Trigger Mode            | On                       |
| Trigger Source          | Self Trigger             |
| Self Trigger Period(ms) | 300                      |
| Self Trigger Count      | 0                        |
| Self Trigger Start      | Execute                  |
| Self Trigger Stop       | Execute                  |
| Trigger Cache           | <input type="checkbox"/> |

Figure 8-30 Set and Execute Self Trigger Mode

### 8.3.4 Stop Trigger

Stop trigger settings configure the source and condition to stop trigger. You can stop device trigger via TCP, UDP, I/O and serial port.

#### TCP Stop Trigger

When the TCP server receives the specified string text, the trigger will be stopped.

Click **I/O Control Settings** → **Stop Trigger**, enable **Tcp Stop Trigger Enable**, set **Tcp Trigger Port** and **Tcp Stop Trigger Text** according to actual demands.

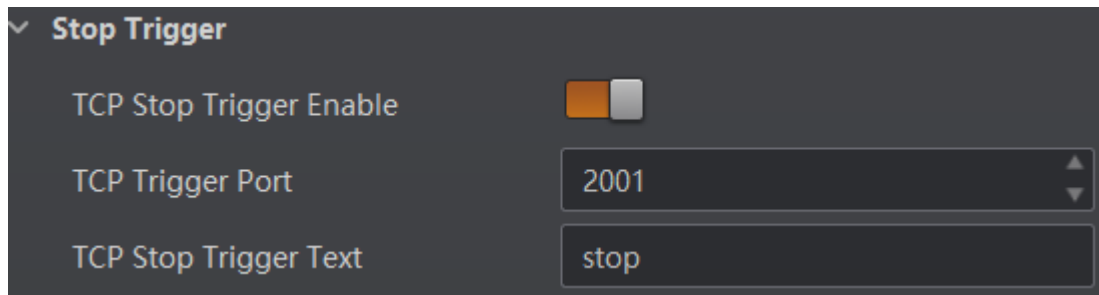


Figure 8-31 TCP Stop Trigger

#### UDP Stop Trigger

When the UDP server receives the specified string text, the trigger will be stopped.

Click **I/O Control Settings** → **Stop Trigger**, enable **Udp Stop Trigger Enable**, set **Udp Trigger Port** and **Udp Stop Trigger Text** according to actual demands.

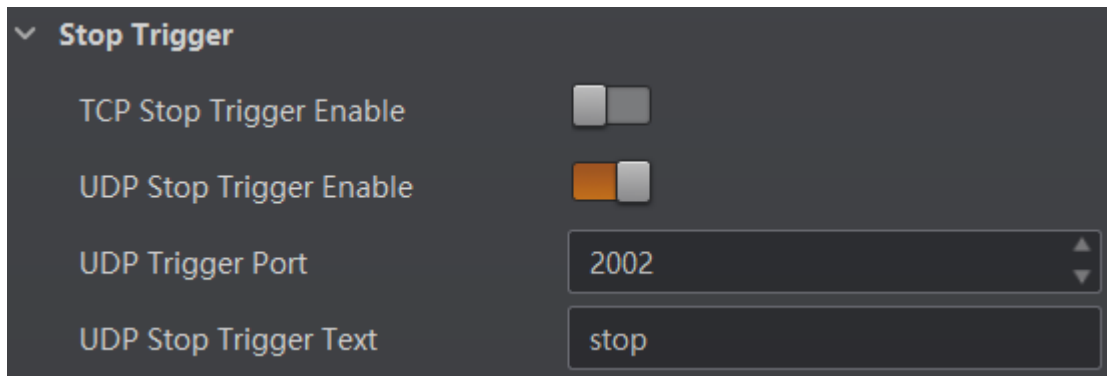


Figure 8-32 UDP Stop Trigger

#### IO Stop Trigger

You can select the physical line or software from **IO Stop Trigger Selector** as the source to stop trigger, and set the **Rising Edge** or **Falling Edge** as the condition to stop trigger.

Click **I/O Control Settings** → **Stop Trigger**, enable **IO Stop Trigger Enable**, and set **LineIn 0**, **LineIn 1**, **LineIn 2** or **Software Trigger End** as **IO Stop Trigger Selector**.

You can set **Rising Edge** or **Falling Edge** as **Stop Trigger In Polarity** to stop trigger when selecting physical line as **IO Stop Trigger Selector**.

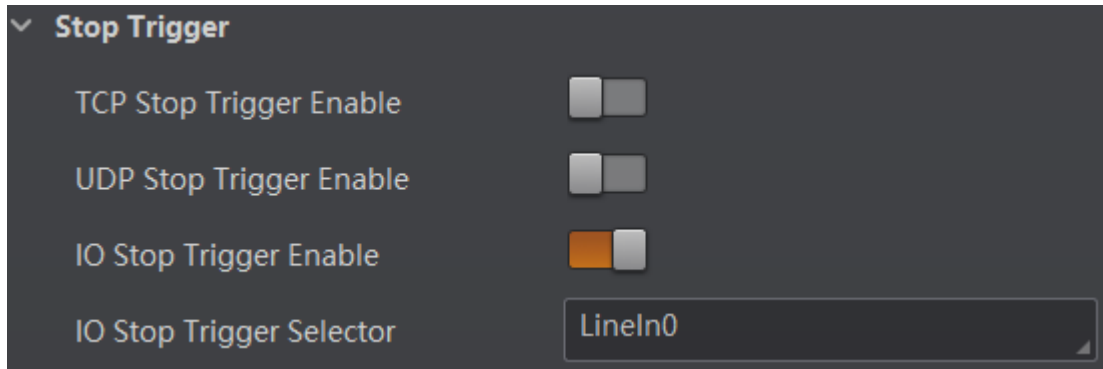


Figure 8-33 IO Stop Trigger

When selecting **Software Trigger End** as **IO Stop Trigger Selector**, you can click **Execute** in **Software Stop Trigger** to stop current trigger.

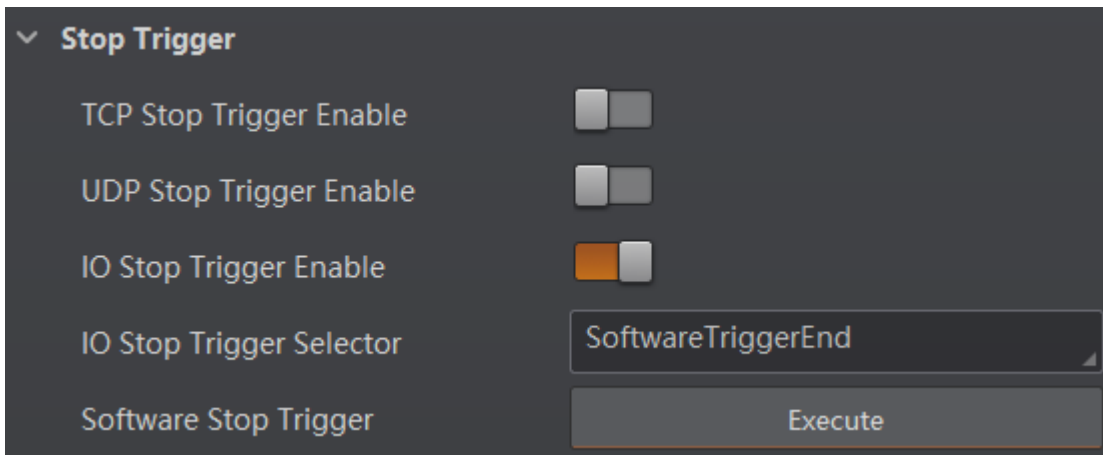


Figure 8-34 Software Trigger End

### Serial Stop Trigger

When the specified serial port receives the specified string text, the trigger will be stopped. Click **I/O Control Settings** → **Stop Trigger**, enable **Serial Stop Trigger Enable**, set **Serial Stop Trigger Text**, **Serial Baud Rate**, **Serial Data Bits**, **Serial parity**, and **Serial Stop Bits** according to actual demands.

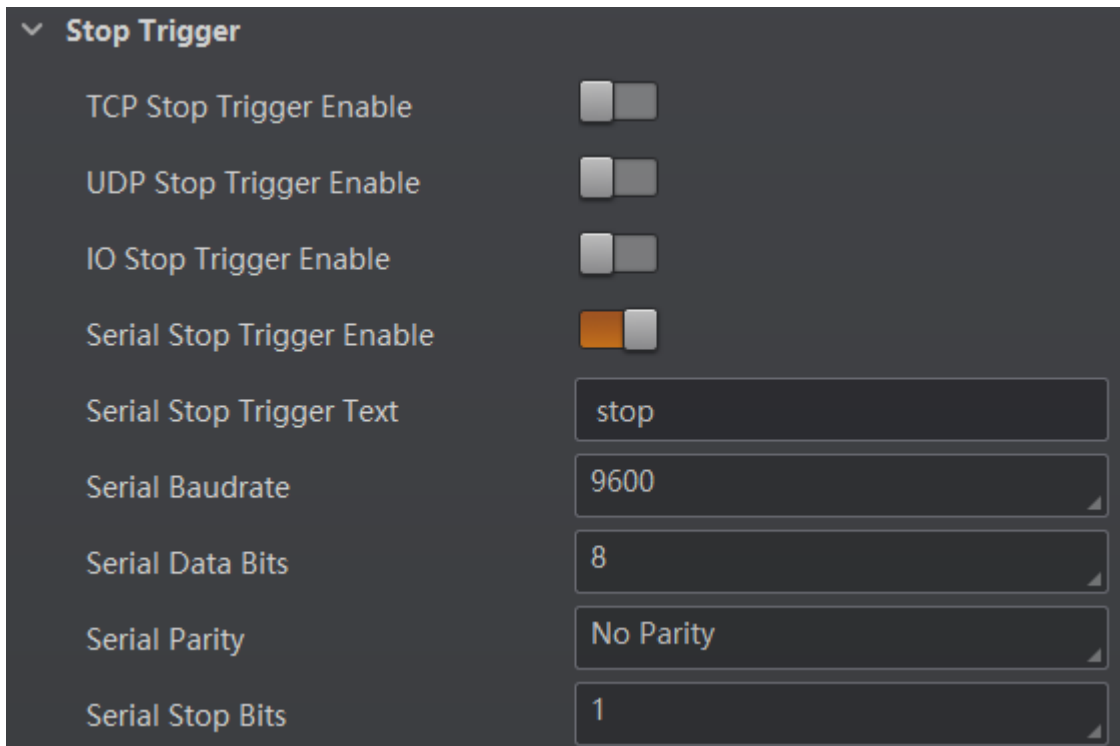


Figure 8-35 Serial Stop Trigger

### Stop Trigger via Timeout Duration

#### Note

**TimeOut Stop Trigger Enable** is only available when the device mode is set to **Normal** and the **Trigger Mode** is **On**.

When the trigger time reaches the specified maximum value (in ms), the trigger will be stopped. You can enable **TimeOut Stop Trigger Enable**, and set **Maximum Output Limited Time** according to actual demands.

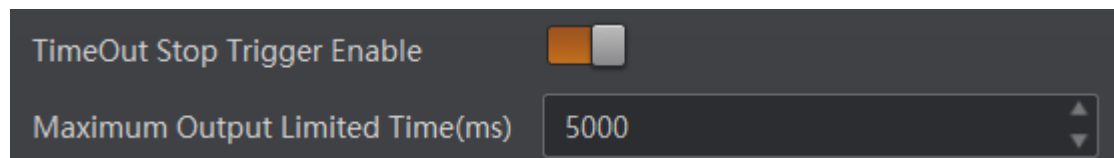


Figure 8-36 Stop Trigger via Timeout Duration

## Stop Trigger via Code Number

### Note

**CodeNum Stop Trigger Enable** is only available when the device mode is set to **Normal** and the **Trigger Mode** is **On**.

This function means that the code quantity outputted by the device is restricted to the settings you configured here. You can enable **CodeNum Stop Trigger Enable**, and set **CodeNum Stop Trigger Min** and **CodeNum Stop Trigger Max** according to actual demands.

- If the outputted code quantity is smaller than configured **CodeNum Stop Trigger Min**, and the device will output codes continuously.
- If the outputted code quantity is smaller than configured **CodeNum Stop Trigger Max**, and the device will stop outputting codes.
- If the outputted code quantity is between configured **CodeNum Stop Trigger Min** and **CodeNum Stop Trigger Max**, and the device will read and output codes according to trigger signals.
- If **CodeNum Stop Trigger Min** is same with **CodeNum Stop Trigger Max**, and the device will stop outputting codes when the number of outputted codes reaches the configured number.

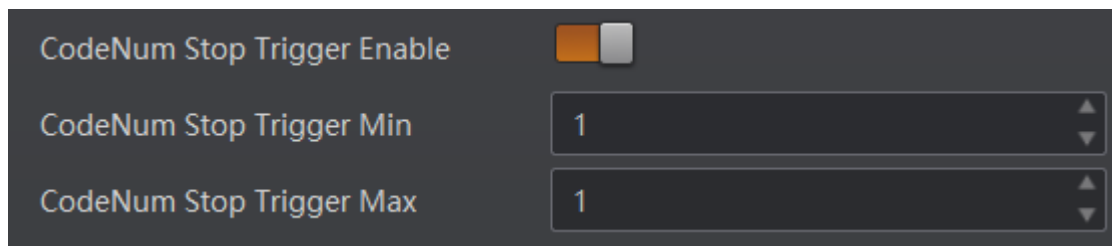


Figure 8-37 Stop Trigger via Code Number

## 8.4 Signal Output Settings

### 8.4.1 Select Output Signal

The device's output signal can control external devices like PLC, flashing light, etc. Click **I/O Control Settings** → **Output** → **Line Out Selector** to select output signal.

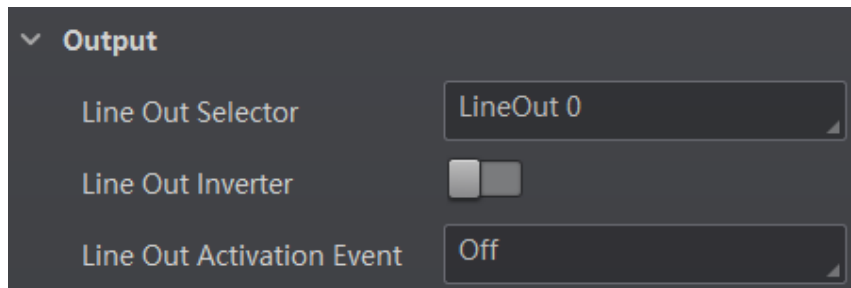


Figure 8-38 Select Output Signal

### 8.4.2 Enable Line Inverter

The level inverter function allows the device to invert the electrical signal level of an I/O line, and meets requirements of different devices for high or low electrical signal level. You can go to **I/O Control Settings** → **Output** → **Line Out Inverter** to enable it.

#### Note

The **Line Out Inverter** function is disabled by default.

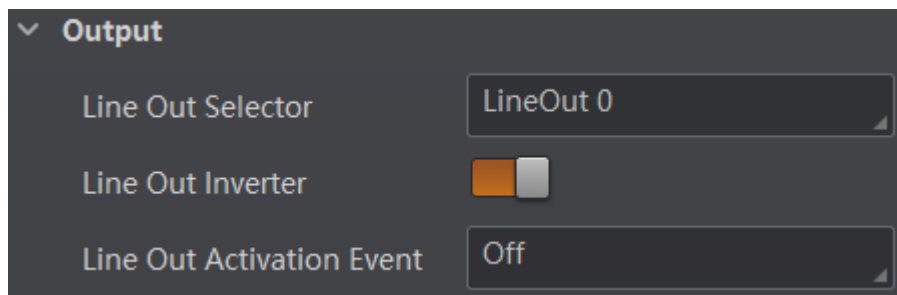


Figure 8-39 Enable Line Out Inverter

### 8.4.3 Set Event Source

The device supports outputting different trigger signals according to the event source you select. Click **I/O Control Settings** → **Output** → **Line Out Activation Event** to select event source.

The device supports following event sources, including **Acquisition Start Active**, **Acquisition Stop Active**, **Frame Burst Start Active**, **Frame Burst Stop Active**, **Exposure Start Active**, **Soft Trigger Active**, **Hard Trigger Active**, **Counter Active**, **Timer Active**, **No Code Read**, **Read Success**, and **Light Strobe Long**, **Compare Success**, and **Compare Fail**.

#### Note

- **Off** refers to no event source.
- Some event sources support the function of trigger output cache, and you can go to **Feature Tree** → **Trigger and IO Control** > **Line Out Cache** to enable it.

**Acquisition Start Active**

If acquisition starts, the output signal will be triggered.

**Acquisition Stop Active**

If acquisition stops, the output signal will be triggered.

**Frame Burst Start Active**

If the burst of a frame starts, the output signal will be triggered.

**Frame Burst Stop Active**

If the burst of a frame stops, the output signal will be triggered.

**Exposure Start Active**

If the exposure starts, the output signal will be triggered.

**Soft Trigger Active**

The client software triggers the output signal.

**Hard Trigger Active**

The external signals trigger the output signal.

**Counter Active**

Trigger the output signal by the counter.

**Timer Active**

The timer triggers the output signal.

**No Code Read**

If no code read by the device, the output signal will be triggered.

**Read Success**

If the code is read by the device, the output signal will be triggered.

**Light Strobe Long**

If the light mode is **Strobe Long**, the output signal will be triggered.

**Compare Success**

If data comparison is successful, the output signal will be triggered.

**Compare Fail**

If data comparison is failed, the output signal will be triggered.

---

 **Note**

You need to set different parameters when selecting these event sources.

---

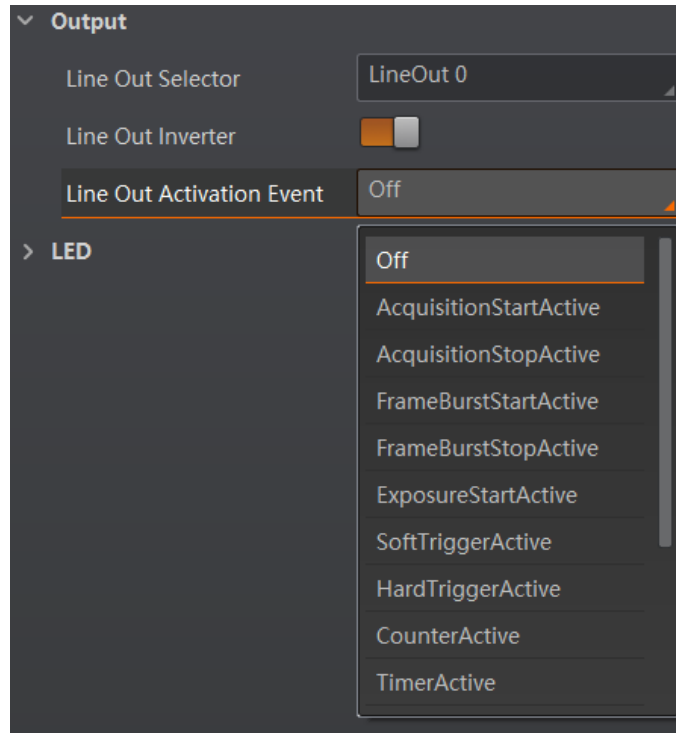


Figure 8-40 Set Event Source

### Select Acquisition Start Active

If you select **Acquisition Start Active** as **Line Out Activation Event**, you can set its output delay time and duration.

#### Line Out Delay Time

It sets the delay time for outputting the output signal.

#### Line Out Duration

It sets the time duration of the output signal.

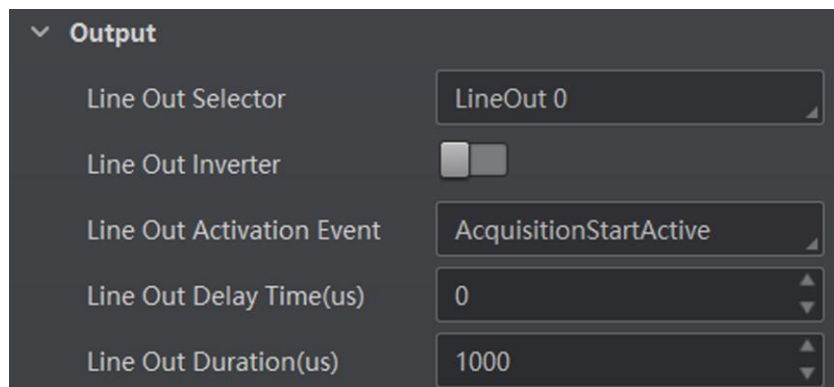


Figure 8-41 Select Acquisition Start Active

### Select Acquisition Stop Active

If you select **Acquisition Stop Active** as **Line Out Activation Event**, you can set its output delay time and duration.

#### Line Out Delay Time

It sets the delay time for outputting the output signal.

#### Line Out Duration

It sets the time duration of the output signal.

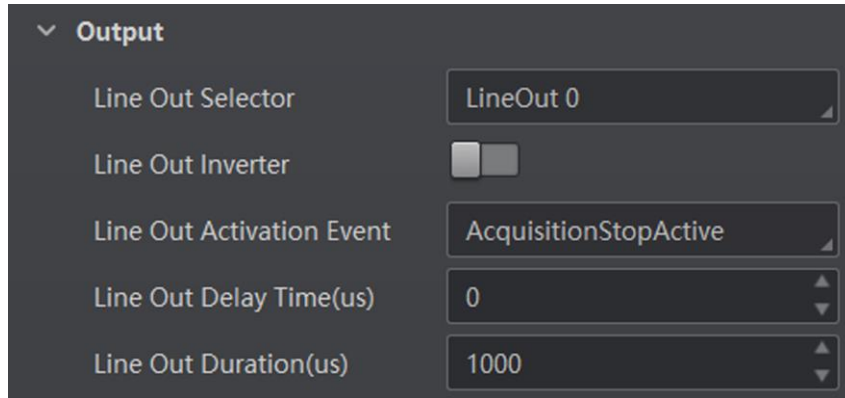


Figure 8-42 Select Acquisition Stop Active

### Select Frame Burst Start Active

If you select **Frame Burst Start Active** as **Line Out Activation Event**, you can set its output delay time and duration.

#### Line Out Delay Time

It sets the delay time for outputting the output signal.

#### Line Out Duration

It sets the time duration of the output signal.

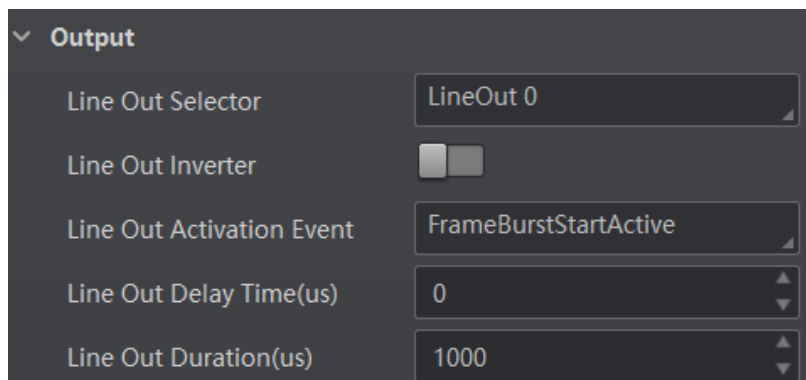


Figure 8-43 Select Frame Burst Start Active

### Select Frame Burst Stop Active

If you select **Frame Burst Stop Active** as **Line Out Activation Event**, you can set its output delay time and duration.

#### Line Out Delay Time

It sets the delay time for outputting the output signal.

#### Line Out Duration

It sets the time duration of the output signal.

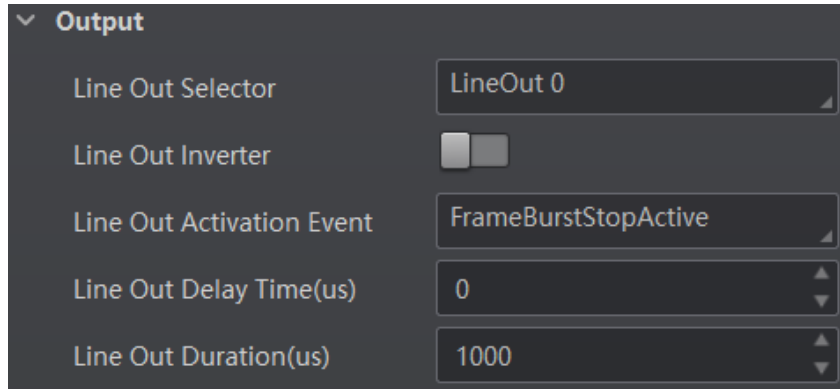


Figure 8-44 Select Frame Burst Stop Active

### Select Exposure Start Active

If you select **Exposure Start Active** as **Line Out Activation Event**, you can set its output delay time and duration.

#### Line Out Delay Time

It sets the delay time for outputting the output signal.

#### Line Out Duration

It sets the time duration of the output signal.

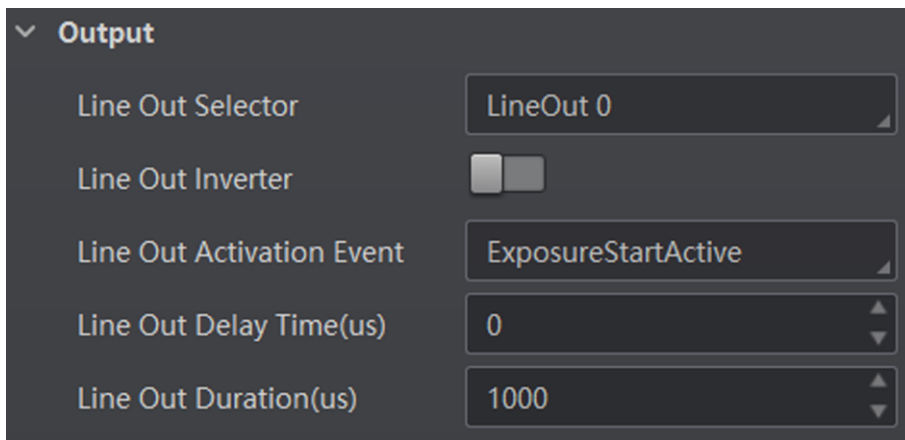


Figure 8-45 Select Exposure Start Active

## Select Soft Trigger Active

If you select **Soft Trigger Active** as **Line Out Activation Event**, you can set its output delay time, duration, and execute outputting signal manually.

### Line Out Delay Time

It sets the delay time for outputting the output signal.

### Line Out Duration

It sets the time duration of the output signal.

### Line Trigger Software

Click **Execute** for manually outputting the output signal.

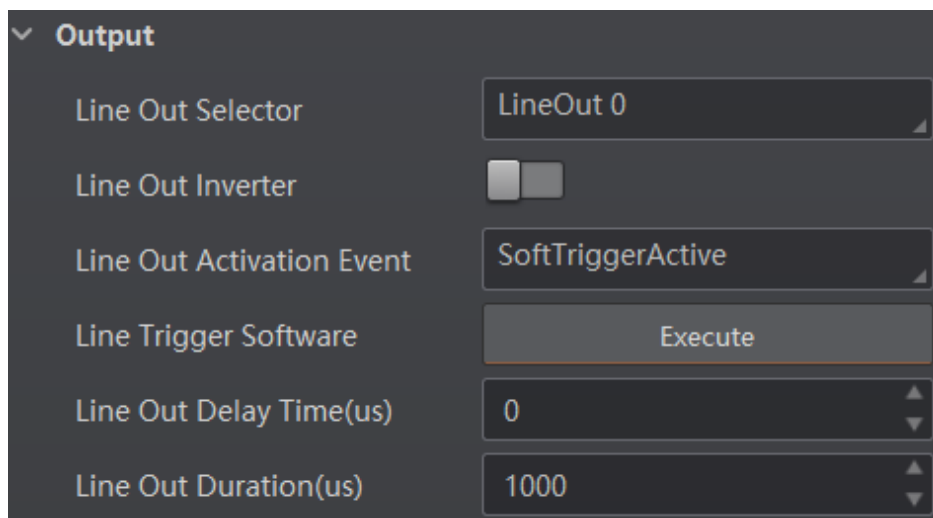


Figure 8-46 Select Soft Trigger Active

## Select Hard Trigger Active

If you select **Hard Trigger Active** as **Line Out Activation Event**, you can set its output delay time, duration, trigger source, and trigger activation.

### Line Out Delay Time

It sets the delay time for outputting the output signal.

### Line Out Duration

It sets the time duration of the output signal.

### Hardware Trigger Source

It sets the hardware trigger source, including **LineIn 0**, **LineIn 1**, and **LineIn 2**.

### Hardware Trigger Activation

It sets the trigger activation of input signal, including **Rising Edge** and **Falling Edge**.

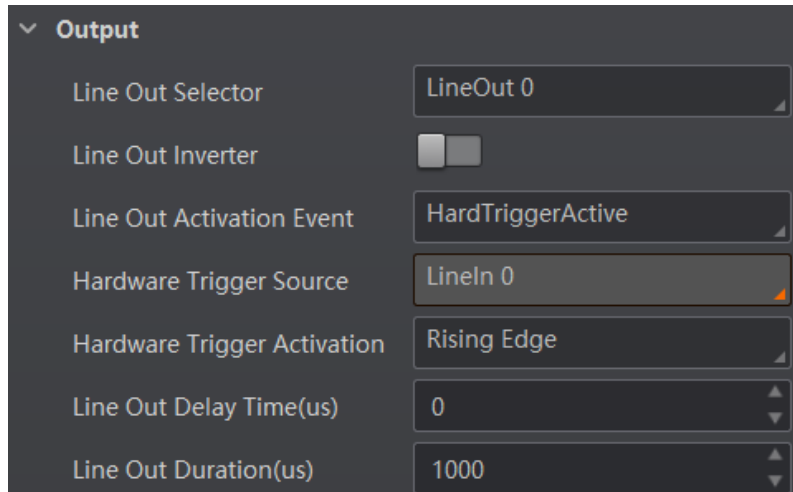


Figure 8-47 Select Hard Trigger Active

### Select Counter Active

If you select **Counter Active** as **Line Out Activation Event**, you can set its output delay time and duration.

#### Line Out Delay Time

It sets the delay time for outputting the output signal.

#### Line Out Duration

It sets the time duration of the output signal.

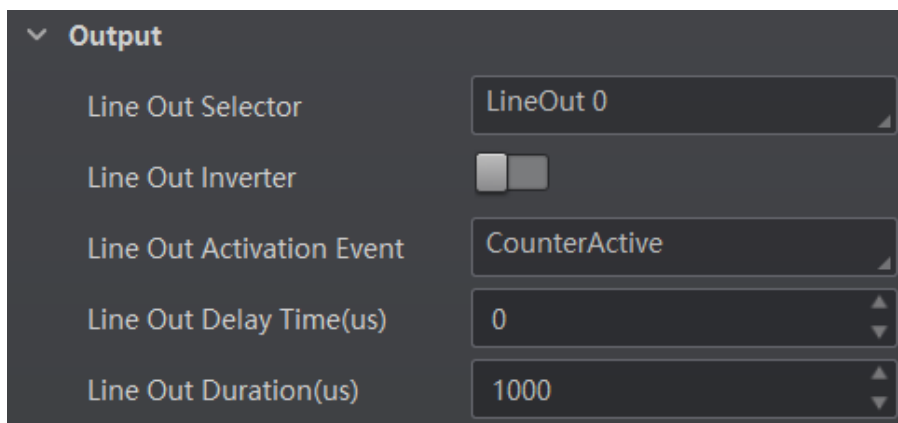


Figure 8-48 Select Counter Active

### Select Timer Active

If you select **Timer Active** as **Line Out Activation Event**, you can set its output duration and period.

#### Line Out Duration

It sets the time duration of the output signal.

### Line Out Period

It sets the time period of the output signal.

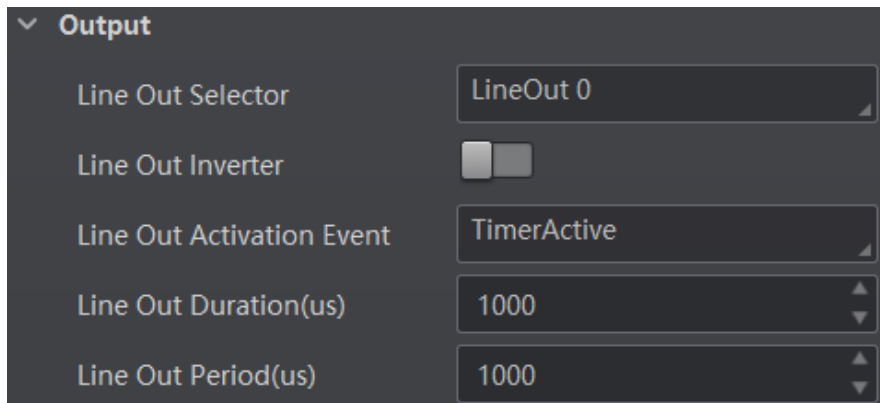


Figure 8-49 Select Timer Active

### Select No Code Read

If you select **No Code Read** as **Line Out Activation Event**, you can set its output delay time and duration.

#### Line Out Delay Time

It sets the delay time for outputting the output signal.

#### Line Out Duration

It sets the time duration of the output signal.

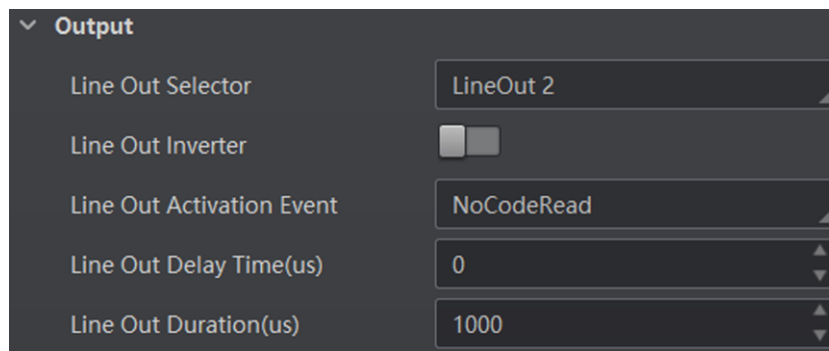


Figure 8-50 Select No Code Read

### Select Read Success

If you select **Read Success** as **Line Out Activation Event**, you can set its output delay time and duration.

#### Line Out Delay Time

It sets the delay time for outputting the output signal.

### Line Out Duration

It sets the time duration of the output signal.

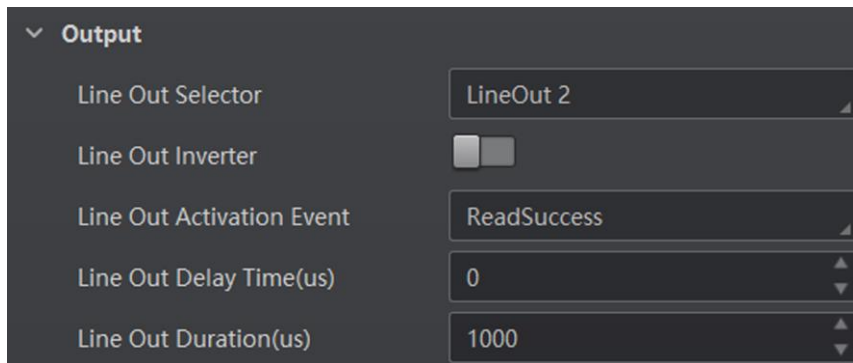


Figure 8-51 Select Read Success

### Select Light Strobe Long

If you select **Light Strobe Long** as **Line Out Activation Event**, you do not need to set any parameters.

### Select Compare Success

If you select **Compare Success** as **Line Out Activation Event**, you can set its output delay time and duration.

#### Line Out Delay Time

It sets the delay time for outputting the output signal.

#### Line Out Duration

It sets the time duration of the output signal.

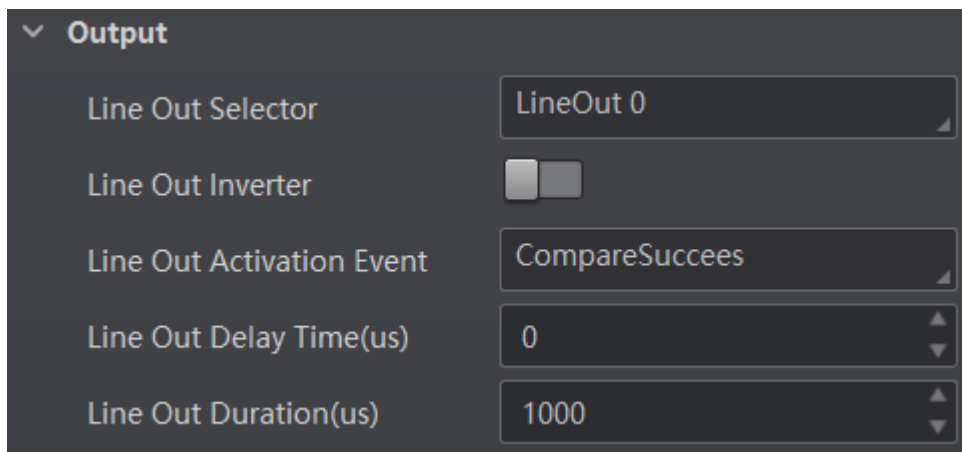


Figure 8-52 Select Compare Success

## Select Compare Fail

If you select **Compare Fail** as **Line Out Activation Event**, you can set its output delay time and duration.

### Line Out Delay Time

It sets the delay time for outputting the output signal.

### Line Out Duration

It sets the time duration of the output signal.

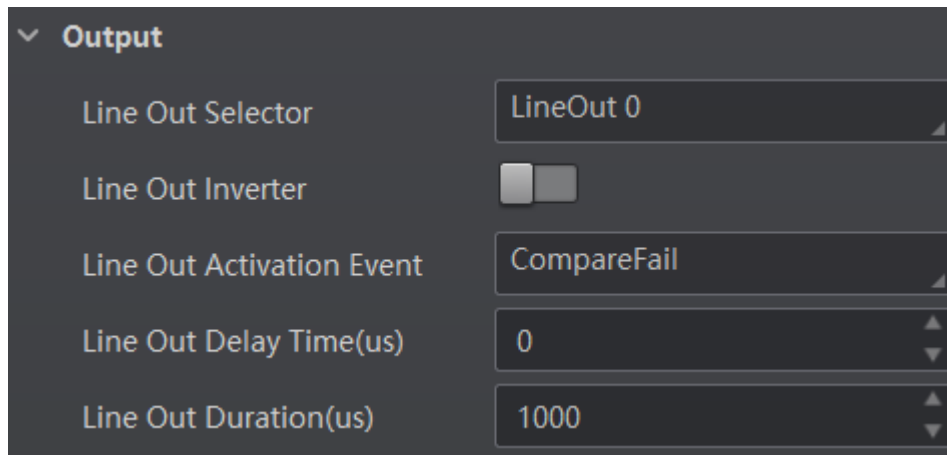


Figure 8-53 Select Compare Fail

## 8.5 Indicator Customization

The device has 2 user-defined indicators, U1 and U2. They are used to indicate whether some functions of the device are normal or not after you selecting specific events.

Go to **I/O Control Settings** → **LED**, and set corresponding events according to actual demands. When the event you select occurs, indicators will flash once.

Table 8-3 Indicator Description

| No. | Parameters     | Description  |
|-----|----------------|--|
| 1   | Off            | No events.   |
| 2   | Read Success   | The indicators flash once when the device reads codes.   |
| 3   | Who Am I       | After selecting <b>Who Am I</b> , you can click <b>Execute</b> to let indicators flash, and know which device you are operating. |
| 4   | System Running | The indicators flash once when the device system operates.   |
| 5   | Be Triggered   | The indicators flash once when the device receives trigger signals.  |
| 6   | LineOut 0      | The indicators flash once when LineOut 0 outputs signals.  |

| No. | Parameters | Description   |
|-----|------------|---|
| 7   | LineOut 1  | The indicators flash once when LineOut 1 outputs signals. |
| 8   | LineOut 2  | The indicators flash once when LineOut 2 outputs signals. |

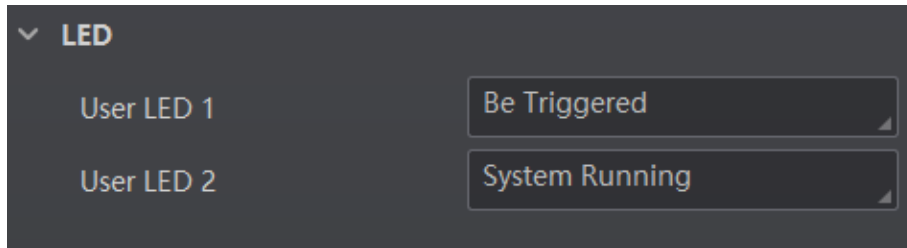


Figure 8-54 Indicator Customization

## 8.6 Code Reading Result Settings

In **Data Processing** module, you can set filter rules for reading barcodes and other data processing related parameters.

### 8.6.1 Set Code Reading Result Output Mode

There are 2 types of output modes when the device mode is **Normal** and trigger mode is **On**: Instant output mode and non-instant output mode.

- Instant output mode means that the device can instantly output code reading results when recognizing codes if you enable **Instant Output Mode Enable** in **Filter Rule**.
- Non-instant output mode means that the device does not output code reading results it recognized until the trigger stops if **Instant Output Mode Enable** is not enabled. If the device does not recognize any codes during the whole process, images it captured will be output, and you can set which images to be outputted in **NoRead Image Index**.

When the device mode is **Normal** and trigger mode is **Off**, you can set **Filter Time** in **Filter Rule**. Within the configured **Filter Time**, the device will not output any code information.

#### Note

The filter rule and data processing parameters may differ with different device modes and trigger modes.

### 8.6.2 Set Filter Rule

You can set rules to filter unwanted barcodes to improve the reading efficiency in **Filter Rule**. Two filter modes are available, including normal mode and regular expression mode. You can set it in

## Filter Mode.

---

### Note

The filter rule parameters may differ with different device modes and trigger modes.

---

## Normal Filter Mode

When the device mode is **Normal**, **Trigger Mode** is **On**, and **Filter Mode** is **Normal**, you can set the following parameters according to actual demands.

### Instant Output Mode Enable

If this parameter is enabled, the device can instantly output code reading result when recognizing codes. If it is not enabled, the device will not output code reading result until the trigger stops.

### Min. Output Time

It sets the min. waiting time before data output. For example, if you set 500 ms as **Minimum Output Time**, the barcode would not be outputted until 500 ms is passed.

### Numeral Filter

If this parameter is enabled, the device will only parse and read the numeral contents of the barcodes, and the non-numeral contents will be filtered out.

### Max Output Length

It sets the max. code length that can be outputted.

### Code Offset Num

It sets the range of barcode to be filtered. For example, the barcode is ABCDEFG, if you set this parameter as 2, the device will output CDEFG at last and filter AB.

### Begin with Specific Character for Result

If this parameter is enabled, the device will only read the barcodes which begin with a specific character. Otherwise, the barcodes will be filtered out. You can enter the specific character in **Begin with**.

### Include Specific Character in Barcode

If this parameter is enabled, the device will only read the barcodes which include a specific character. Otherwise, the barcodes will be filtered out. You can enter the specific character in **Character**.

### Exclude Specific Character in Barcode

If this parameter is enabled, the device will only read the barcodes which exclude a specific character. Otherwise, the barcodes will be filtered out. You can enter the specific character in **Character**.

### Min. Code Length

If the length of a barcode is shorter (in terms of the number of characters contained in the barcode) than the configured value, the device will not parse the contents of the barcode. The

valid value is from 1 to 256. For example, if you set the value as 6, the device will not parse the contents of the barcodes which contain less than 6 characters.

### **Max. Code Length**

If the length of a barcode is longer ((in terms of the number of characters contained in the barcode) than the configured value, the device will not parse the contents of the barcode. The valid value is from 1 to 256. For example, if you set the value as 9, the device will not parse the contents of the barcodes which contain more than 9 characters.

### **Read Times Threshold**

If the reading results of a barcode is same for the configured times, the barcode will be regarded as valid and its reading result will be outputted. Or the barcode will be regarded as invalid and its reading result will not be outputted.

### **De-duplication Enable**

If it is enabled, the repeated code information will be filtered within specific trigger times. You can set trigger times in **De-duplication Windows Size**, and its default value is 1.

### **De-duplication By ROI**

If it is enabled, the device will filter information based on drawn ROIs.

## **Regular Expression Filter Mode**

### **Instant Output Mode Enable**

If this parameter is enabled, the device can instantly output code reading result when recognizing codes. If it is not enabled, the device will not output code reading result until the trigger stops.

### **Min. Output Time**

It sets the min. waiting time before data output. For example, if you set 500 ms as **Minimum Output Time**, the barcode would not be outputted until 500 ms is passed.

### **Max Output Length**

It sets the max. code length that can be outputted.

### **Code Offset Num**

It sets the range of barcode to be filtered. For example, the barcode is ABCDEFG, if you set this parameter as 2, the device will output CDEFG at last and filter AB.

### **Regular Expression**

It selects the regular expression from order 1 to order 10. You can enter specific regular expression contents in **Regular Expression Filter**. Up to ten regular expression rules can be set at the same time. Once one regular expression is met, code can be outputted.

### **Regular Expression Filter**

It sets the specific regular expression contents.

### **Min. Code Length**

If the length of a barcode is shorter (in terms of the number of characters contained in the barcode) than the configured value, the device will not parse the contents of the barcode. The valid value is from 1 to 256. For example, if you set the value as 6, the device will not parse the contents of the barcodes which contain less than 6 characters.

### Max. Code Length

If the length of a barcode is longer ((in terms of the number of characters contained in the barcode) than the configured value, the device will not parse the contents of the barcode. The valid value is from 1 to 256. For example, if you set the value as 9, the device will not parse the contents of the barcodes which contain more than 9 characters.

### Read Times Threshold

If the reading results of a barcode is same for the configured times, the barcode will be regarded as valid and its reading result will be outputted. Or the barcode will be regarded as invalid and its reading result will not be outputted.

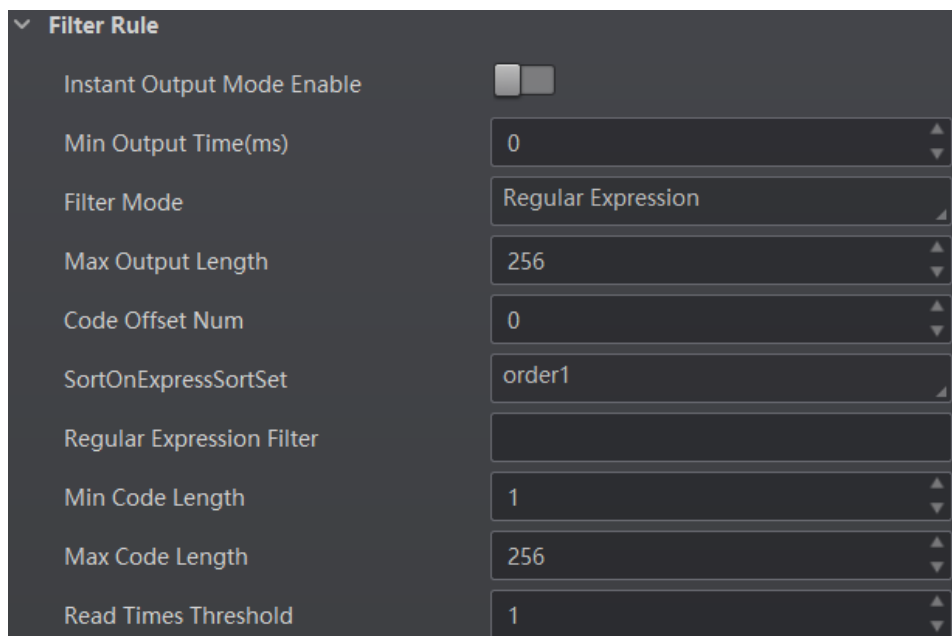


Figure 8-55 Regular Expression Filter Mode

## 8.6.3 Set Result Format

Result format settings allow you to set the format and contents contained in the outputted barcode information. Result format is related to communication protocol and trigger mode. With different selected communication protocol and trigger mode, you need to set corresponding parameters.

### Note

- Result format settings are only available if you select **Smart SDK, TCP Client, TCP Server, Serial, FTP, Profinet, Melsec, Ethernet/IP, ModBus, Fins, and SLMP** as the communication protocol when the device mode is **Normal**.

- For details about communication protocol, see section **Communication Settings** for details.
  - The specific parameter names and values may differ by device firmware versions.
- 

### Result Output via Smart SDK

When the communication protocol is **Smart SDK**, device mode is **Normal** and trigger mode is **On**, you can set following parameters.

#### Sorting Rules

It decides the output order of codes, and you can select it according to actual demands.

#### One By One Enable

If it is enabled, the device will send one piece of code information each time in accordance with the specified interval. You can set the interval via **One By One Interval** and the default value 100 ms.

#### Local Save Picture Mode

It includes **Off** and **NoRead**. You can select **NoRead** to let the device save images when no code is read.

#### Local Picture Type

It sets the image saving type, including JPEG and BMP.

#### Local Override Strategy

It includes **Off**, **Max Count**, **Loop Max Count**, and **Reserve Space**. **Off** means that disk will not be overridden. **Max Count** means that the device will save image quantity configured in **Local Override Max. Count**, and no more imaged will be saved when the disk is full. **Loop Max Count** means that after the image quantity is reached the number configured in **Local Override Max. Count**, the device will delete the first image and continue to save the latest image. **Reserve Space** means that the device will save images when the disk is safe in terms of storage space. If the available disk space is lower than configured value, and images will be deleted.

#### Local Override Max. Count

You need to set this parameter when selecting **Max Count** or **Loop Max Count** as **Local Override Strategy**.

#### Local Picture Name Content

It selects what contents you want to display in file name, including frame time, trigger No. and frame No.

#### Local Time Format

It selects a format type from the drop-down list for the time stamp contained in the file name. Take YYYYMMDD\_HHMMSSFFF as an example, (from the left to the right) YYYY represents year, MM represents month, DD represents date, HH represents hour, MM represents minute, SS represents second, and FFF represents millisecond.

#### Local Save Picture Strategy

It sets the picture saving method. Four methods are available, including recently frame, all frames, range frames and specific frame. If specific frame is selected as **Local Save Picture Strategy**, you need to set **Local Picture Index**.

### Result Output via FTP

The device also supports using the FTP communication protocol to send and receive data, and you can select it to output information. The configurable parameters below are related to the trigger mode, and here we take the external trigger mode as an example.

---

#### Note

The configurable parameters may differ if the internal trigger mode is enabled.

---

### Sorting Rules

It decides the output order of codes, and you can select it according to actual demands.

### One By One Enable

If it is enabled, the device will send one piece of code information each time in accordance with the specified interval. You can set the interval via **One By One Interval** and the default value 100 ms.

### Local Save Picture Mode

It includes **Off** and **NoRead**. You can select **NoRead** to let the device save images when no code is read.

### Local Picture Type

It sets the image saving type, including JPEG and BMP.

### Local Override Strategy

It includes **Off**, **Max Count**, **Loop Max Count**, and **Reserve Space**. **Off** means that disk will not be overridden. **Max Count** means that the device will save image quantity configured in **Local Override Max. Count**, and no more imaged will be saved when the disk is full. **Loop Max Count** means that after the image quantity is reached the number configured in **Local Override Max. Count**, the device will delete the first image and continue to save the latest image. **Reserve Space** means that the device will save images when the disk is safe in terms of storage space If the available disk space is lower than configured value, and images will be deleted.

### Local Override Max. Count

You need to set this parameter when selecting **Max Count** or **Loop Max Count** as **Local Override Strategy**.

### Local Picture Name Content

It selects what contents you want to display in file name, including frame time, trigger No. and frame No.

### Local Time Format

It selects a format type from the drop-down list for the time stamp contained in the file name. Take YYYYMMDD\_HHMMSSFFF as an example, (from the left to the right) YYYY represents year, MM represents month, DD represents date, HH represents hour, MM represents minute, SS represents second, and FFF represents millisecond.

### Local Save Picture Strategy

It sets the picture saving method. Four methods are available, including recently frame, all frames, range frames and specific frame. If specific frame is selected as **Local Save Picture Strategy**, you need to set **Local Picture Index**.

### Output Retrans Enable

If this parameter is enabled, the data is allowed to retransmit to FTP server, and you should set specific value in **Output Retrans Number**.



#### Note

If data retransmission is still failed after the times allowed for data retransmission is reached, the retransmission will be discarded.

---

### FTP Picture Name Content

It selects what contents you want to display in FTP file name, including code content, code type, frame number, etc. You can select multiple contents as desired, and the selected contents will be displayed below.

### FTP Transmission Conditions

It sets the condition to upload the data outputted by the device to FTP server. **All** refers to upload the data always. **Read Barcode** refers to upload the data only when the barcode is read by the device. **No Read Barcode** refers to upload the data only when no barcode is read by the device.

### FTP Transmission Result Contain

It selects contents to upload to the FTP server. **Just Result** refers to only upload the content of the barcode. **Just Picture** refers to only upload the barcode picture. **Result and Picture** refers to upload both the content of the barcode and the picture.

### FTP Time Format

It selects a format type from the drop-down list for the time stamp contained in the file name. Take YYYYMMDD\_HHMMSSFFF as an example, (from the left to the right) YYYY represents year, MM represents month, DD represents date, HH represents hour, MM represents minute, SS represents second, and FFF represents millisecond.

### FTP Result Prefix

It sets the prefix of FTP file name, including **No**, **Result** and **All**. **No** stands for no prefix for file name, and all images are saved in FTP root directory. **Result** stands for all images that code reading successfully will be saved in Read directory, and all images that code reading failed will be saved in Noread directory. **All** stands for all images will be saved in All directory.

### FTP Save Picture Strategy

It sets the FTP picture saving method when no code is read. Four methods are available, including recently frame, all frames, range frames and specific frame. If specific frame is selected as **FTP Save Picture Strategy**, you need to set **FTP Picture Index**.

## Result Output via Other Communication Protocols

When the communication protocol is **TCP Client, TCP Server, Serial, Profinet, Melsec, Ethernet/IP, ModBus, Fins** or **SLMP**, device mode is **Normal** and trigger mode is **On**, you can set following parameters.

---

### Note

- The configurable parameters may differ if the internal trigger mode is enabled.
  - Here we take **Profinet** as **Communication Protocols** as an example to introduce parameters. Regarding other communication protocols, the configurable parameters are similar with slight difference in term of parameter names., and refer to the actual device you got for details.
- 

## Sorting Rules

It decides the output order of codes, and you can select it according to actual demands.

### One By One Enable

If it is enabled, the device will send one piece of code information each time in accordance with the specified interval. You can set the interval via **One By One Interval** and the default value 100 ms.

### ROI Output NoRead Enable

If it is enabled, codes will be outputted in turn according to the **ROI Selector** of the algorithm ROI they belong.

### Local Save Picture Mode

It includes **Off** and **NoRead**. You can select **NoRead** to let the device save images when no code is read.

### Local Picture Type

It sets the image saving type, including JPEG and BMP.

### Local Override Strategy

It includes **Off, Max Count, Loop Max Count**, and **Reserve Space**. **Off** means that disk will not be overridden. **Max Count** means that the device will save image quantity configured in **Local Override Max. Count**, and no more imaged will be saved when the disk is full. **Loop Max Count** means that after the image quantity is reached the number configured in **Local Override Max. Count**, the device will delete the first image and continue to save the latest image. **Reserve Space** means that the device will save images when the disk is safe in terms of storage space If the available disk space is lower than configured value, and images will be deleted.

### Local Override Max. Count

You need to set this parameter when selecting **Max Count** or **Loop Max Count** as **Local Override**

**Strategy.**

**Local Picture Name Content**

It selects what contents you want to display in file name, including frame time, trigger No. and frame No.

**Local Time Format**

It selects a format type from the drop-down list for the time stamp contained in the file name. Take YYYYMMDD\_HHMMSSFFF as an example, (from the left to the right) YYYY represents year, MM represents month, DD represents date, HH represents hour, MM represents minute, SS represents second, and FFF represents millisecond.

**Local Save Picture Strategy**

It sets the picture saving method. Four methods are available, including recently frame, all frames, range frames and specific frame. If specific frame is selected as **Local Save Picture Strategy**, you need to set **Local Picture Index**.

**Profinet Output Format**

It selects what contents you want to output, including code content, code type, angle, trigger start time, code score, etc. You can select multiple contents according to actual demands.

**Profinet Format Check**

You should click **Execute** in **Profinet Format Check** to check if you entered is right in format, and the check result will be displayed in **Profinet Format Check Result**.

**Profinet Output NoRead**

If it is enabled, and the device will output the content you set in **Profinet Output NoRead Text** when no code is recognized.

**Profinet Output Start Text**

The contents of the start part of the data outputted. You can set the contents according to actual condition.

**Profinet Output Stop Text**

The contents of the end part of the data outputted. You can set the contents according to actual condition.

**Profinet Output Barcode Enter Character Enable**

If it is enabled, enter character will be outputted.

**Profinet Output Barcode Newline Character Enable**

If it is enabled, a newline will be outputted.

**Profinet Output Barcode Carriage Return Enable**

If it is enabled, a carriage return will be outputted.

**Profinet Add NoRead Enable**

You can add contents to let the device output codes when the code recognized by the device does

not meet the min. length requirement. It includes **Off**, **Add Noread**, and **Just Noread**. **Off** does not add contents and the device outputs code recognized only. **Add Noread** allows you to add contents to the min. length requirement and output. **Just Noread** means that the device outputs **Noread** only if the code recognized by the device does not meet the min. length requirement.

### Code Pos Width Enable

If it is enabled, you can add 0 to codes if the code coordinate does not meet specified length.

### Code Pos Width

You can enter the length of the code coordinate after enabling **Code Pos Width Enable**.

### CodeNum End Trigger Min

If it is enabled, the device will stop triggering and save the current image when the code recognized by the device does not meet the min. length requirement.

## 8.7 Contrast Control Settings

---



### Note

You need to set device mode as **Normal** before using this function.

---

The contrast control function compares the data that the device reads with preset data and outputs contrast result. The result can be used as the event source of trigger signal, including **Contrast Success** and **Contrast Fail**. This function has two ways to contrast, including regular contrast and consecutive number contrast.

### Regular Contrast

The regular contrast requires you to set code contents in advance, and the client software will contrast the data that the device reads with preset contents and outputs comparison result.

### Steps

1. Right click the device in **Device Connection**, and click **Feature Tree**.
2. Go to **Contrast Control**, enable **Contrast Enable**, and select **Regular** as **Contrast Rules**.
3. Set **Start Position** that means the starting position of the comparison.
4. Set **Character Number** that means the comparison quantity.
5. Set code contents in **Wildcard String**.



### Note

You can use wildcard \* and ?. \* stands for multiple strings you can use, and ? stands for one string you can use. \* can be used once only and ? can be used many times.

---

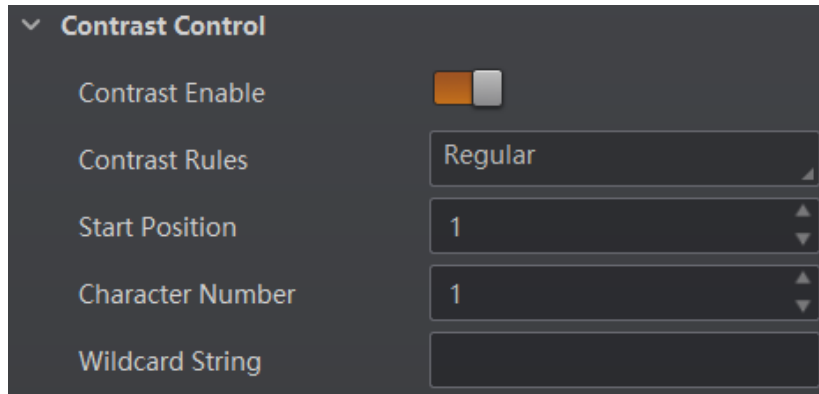


Figure 8-56 Regular Contrast

## Consecutive Number Contrast

The consecutive number contrast requires you to set consecutive code rules, and the client software will contrast the data that the device reads with preset rules and outputs contrast result.

### Steps

1. Right click the device in **Device Connection**, and click **Feature Tree**.
2. Go to **Contrast Control**, enable **Contrast Enable**, and select **Consecutive Number** as **Compare Rules**.
3. Set **Start Position** that means the starting position of the comparison.
4. Set **Digital Number** that means the comparison quantity.
5. Set **Step** that means the client software will increase or decrease the preset value after each comparison according to the step you set.

### Note

- If the preset value after increase or decrease exceeds the digital number you set, and then the preset value will become 0.
- The base value displays the preset value.

6. (Optional) Click **Execute** in **Contrast Reset** to reset comparison. After that, the client software will use the first code it reads as the preset value.

Here we take start position (3), digital number (2) and step (2) as an example to explain the consecutive number comparison:

- If the first code that the device reads is ur96k, and then the preset value is 96. The preset value increases to 98 (96+2).
- If the second code is yr98kjkfd, and comparison succeeds. The preset value increases to 100 (98+2).
- If the third code is kl99fjkd, and comparison fails. The preset value does not increase.
- If the fourth code is kl00djf, and comparison succeeds. The preset value increases to 02 (00+2).

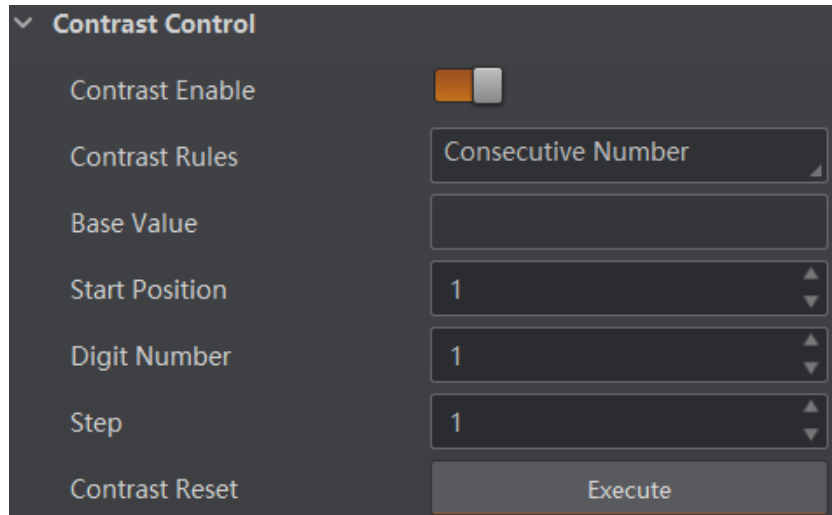


Figure 8-57 Consecutive Number Contrast

## 8.8 Communication Settings

The communication protocol is used to transmit and output code reading result and image. The communication protocol is related to the device modes. With various device modes, the device supports different communication protocols and corresponding parameters.

When the device mode is **Test** or **Raw**, the device only supports **Smart SDK** protocol and no parameter settings are required. While in **Normal** mode, the device supports **Smart SDK**, **TCP Client**, **TCP Server**, **Serial**, **FTP**, **Profinet**, **Melsec**, **Ethernet/IP**, **ModBus**, **Fins** and **SLMP** communication protocols, and you need to set corresponding parameters.

### Note

The specific communication parameters may differ by device models and firmware.

### 8.8.1 Smart SDK

If **Smart SDK** is selected as the **Communication Protocols**, you can enable **SmartSdk Protocol** to let the device output data via **Smart SDK**.

#### Encode JPG Flag

If enabled, the device will compress the image data.

#### Quantity of Jpg

You can enter a number (range: 50 to 99) to determine the compression quality

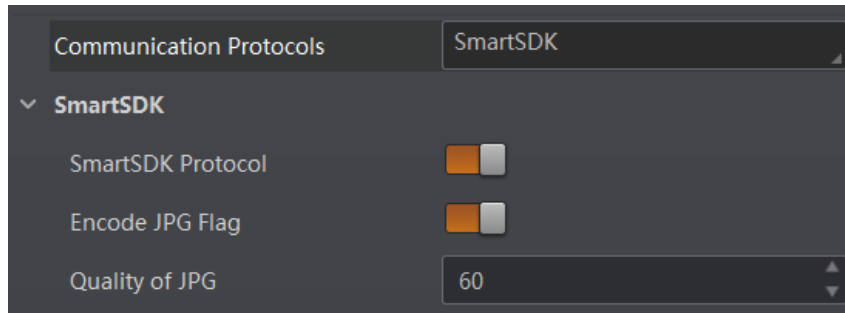


Figure 8-58 Smart SDK

### 8.8.2 TCP Client

The TCP includes **TCP Server** and **TCP Client**. If **TCP Client** is selected as the **Communication Protocols**, you can enable **TCP Protocol**, and enter **TCP Dst Addr** and **TCP Dst Port**.

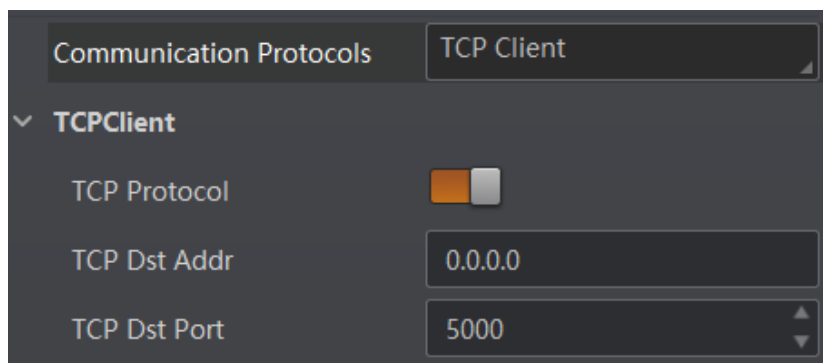


Figure 8-59 TCP Client

### 8.8.3 TCP Server

The TCP includes **TCP Server** and **TCP Client**. If **TCP Server** is selected as the **Communication Protocols**, you can enable **TCP Server Enable**, and enter **TCP Server Port**.

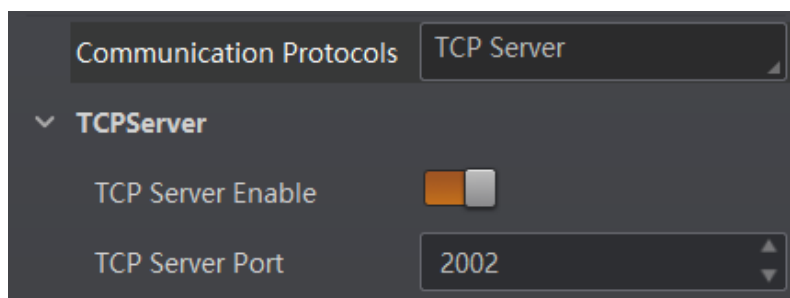
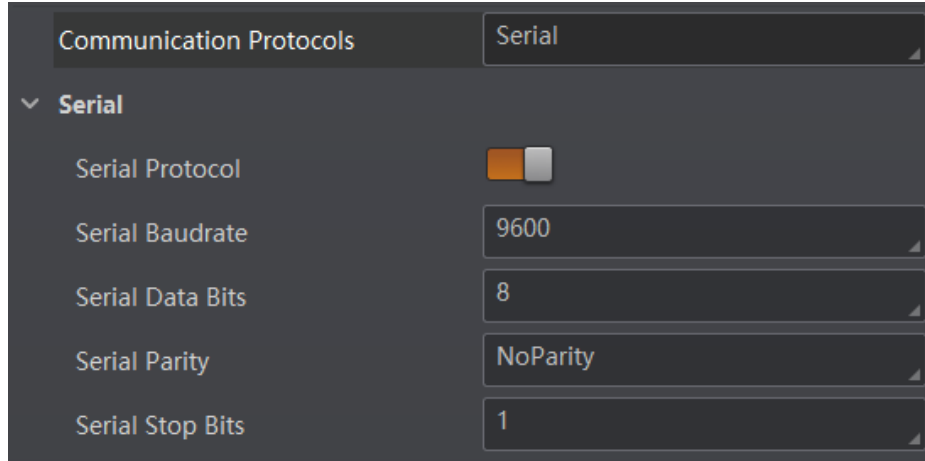


Figure 8-60 TCP Server

### 8.8.4 Serial

If **Serial** is selected as the **Communication Protocols**, you can enable **Serial Protocol**, enter **Serial Baud Rate**, **Serial Data Bits**, **Serial Parity**, and **Serial Stop Bits**.

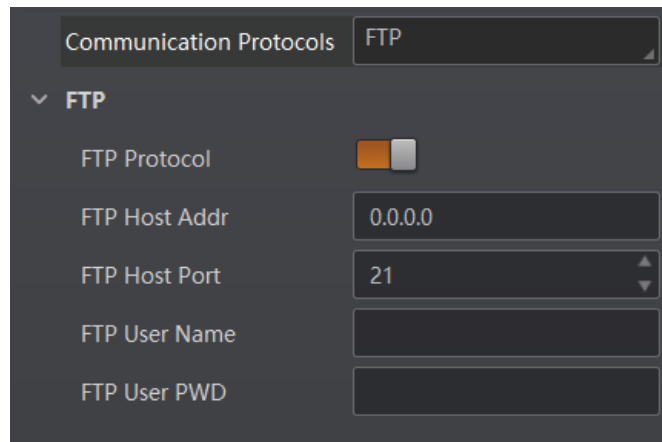


The screenshot shows a configuration window with a dark background. At the top, there is a dropdown menu labeled 'Communication Protocols' with 'Serial' selected. Below this, a section titled 'Serial' is expanded, showing several settings: 'Serial Protocol' is a toggle switch that is turned on (orange); 'Serial Baudrate' is a dropdown menu set to '9600'; 'Serial Data Bits' is a dropdown menu set to '8'; 'Serial Parity' is a dropdown menu set to 'NoParity'; and 'Serial Stop Bits' is a dropdown menu set to '1'.

Figure 8-61 Serial

### 8.8.5 FTP

If **FTP** is selected as the **Communication Protocols**, you can enable **FTP Protocol**, enter **FTP Host Addr**, **FTP Host Port**, **FTP User Name**, and **FTP User PWD**.



The screenshot shows a configuration window with a dark background. At the top, there is a dropdown menu labeled 'Communication Protocols' with 'FTP' selected. Below this, a section titled 'FTP' is expanded, showing several settings: 'FTP Protocol' is a toggle switch that is turned on (orange); 'FTP Host Addr' is a text input field containing '0.0.0.0'; 'FTP Host Port' is a spinner control set to '21'; 'FTP User Name' is an empty text input field; and 'FTP User PWD' is an empty text input field.

Figure 8-62 FTP

### 8.8.6 Profinet

If **Profinet** is selected as the **Communication Protocols**, you can enable **Profinet Enable** and set **Profinet Device Name** according to actual demands.

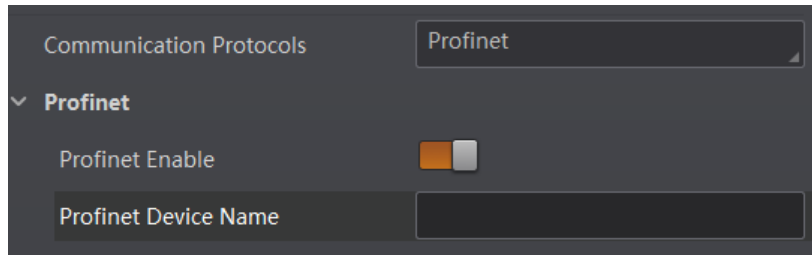


Figure 8-63 Profinet

### 8.8.7 MELSEC

If **MELSEC** is selected as the **Communication Protocols**, you can enable **MELSEC Protocol Enable** and set related parameters according to actual demands.

#### **MELSEC Destination Address**

It sets the IP address of the target PLC.

#### **MELSEC Destination Port**

It sets the port number of the target PLC.

#### **MELSEC Data Base Address**

It sets the first address of the data area.

#### **MELSEC State Base Address**

It sets the first address of the status area.

#### **MELSEC Network Number**

It sets the network No.

#### **MELSEC PLC Number**

It sets the PLC No.

#### **MELSEC Module I/O Number**

It sets the target module's I/O number.

#### **MELSEC Module Station Number**

It displays the module station number.

#### **MELSEC Timeout**

It sets the waiting time before the returning of PLC's response.

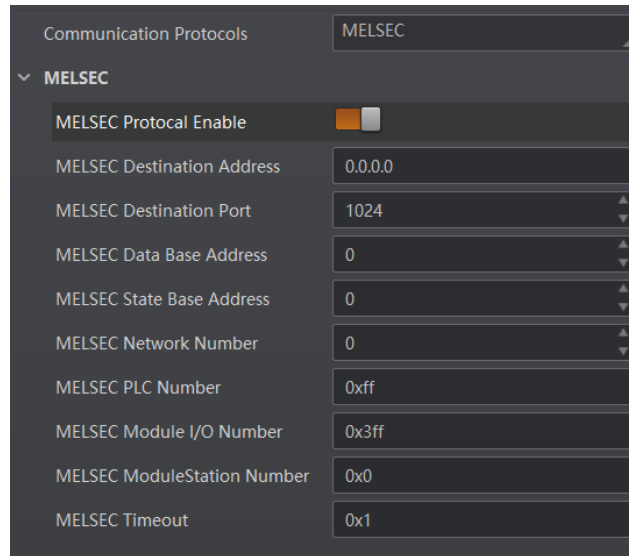


Figure 8-64 MELSEC

### 8.8.8 Ethernet/IP

If **Ethernet/IP** is selected as the **Communication Protocols**, you can enable **Ethernet/IP Enable**, and the device will output data via Ethernet/IP.

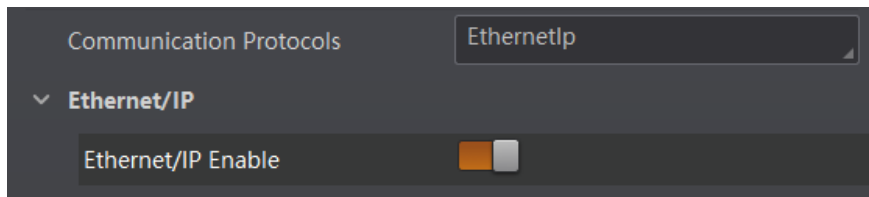


Figure 8-65 Ethernet/IP

### 8.8.9 ModBus

If **ModBus** is selected as the **Communication Protocols**, you can enable **ModBus Enable** and set related parameters according to actual demands.

#### ModBus Mode

It includes server and client, and is server by default.

---

#### Note

If client is selected as **ModBus Mode**, you need to set **ModBus Server IP**, **ModBus Server Port** and **ModBus Scan Rate (ms)**.

---

#### ModBus Control Address Space

It is holding\_register by default.

**ModBus Control Address Offset**

It refers to the address offset, and is 0 by default.

**ModBus Control Data Number**

It is 2 by default.

**ModBus State Address Space**

It is input\_register by default.

**ModBus State Address Offset**

It is 0 by default.

**ModBus State Data Number**

It is 2 by default.

**ModBus Result Address Space**

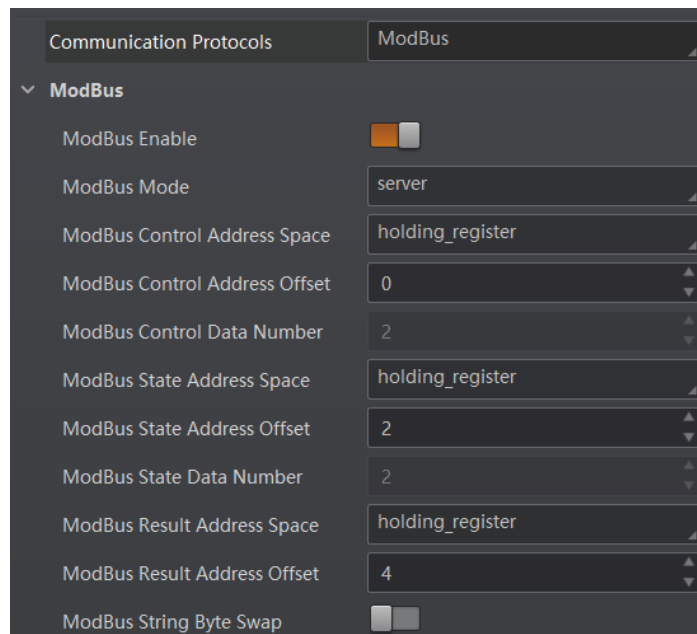
It is input\_register by default.

**ModBus Result Address Offset**

It is 4 by default.

**ModBus String Byte Swap**

If it is enabled, string byte is saved by big-endian. If it is not enabled, string byte is saved by little-endian.



**Figure 8-66 ModBus**

**8.8.10 Fins**

If **Fins** is selected as the **Communication Protocols**, you can enable **Fins Enable** and set related

parameters according to actual demands.

**Fins Communication Mode**

It includes UDP or TCP.

**Fins Local Port**

It is 9600 by default.

**Fins Dst IP**

It sets the IP address of the target device.

**Fins Dst Port**

It sets the port of the target device.

**Fins Data Format**

It includes 16-bit or 32-bit.

**Fins Scan Rate (ms)**

It sets the interval that the device reads the server's control register, and the unit is ms.

**Fins Control Area**

It is saved in DM area by default.

**Fins Control Addr**

You can set it according to actual demands. Make sure that each area cannot be overlapped and covered.

**Fins State Area**

It is saved in DM area by default.

**Fins State Addr**

You can set it according to actual demands. Make sure that each area cannot be overlapped and covered.

**Fins Result Area**

It is saved in DM area by default.

**Fins Result Addr**

You can set it according to actual demands. Make sure that each area cannot be overlapped and covered.

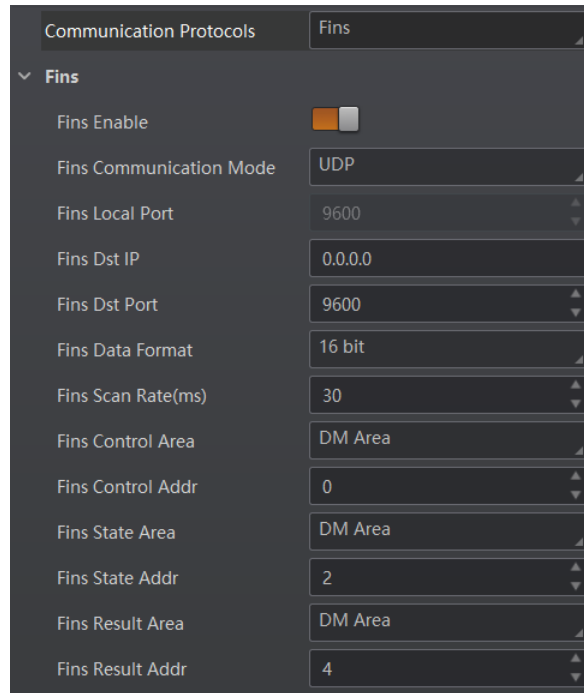


Figure 8-67 Fins

### 8.8.11 SLMP

If **SLMP** is selected as the **Communication Protocols**, you can enable **SLMP Enable** and set related parameters according to actual demands.

#### SLMP Dst Addr

It sets the IP address of the target PLC.

#### SLMP Dst Port

It sets the port number of the target PLC.

#### SLMP Data Base Addr

It sets the first address of the data area.

#### SLMP State Base Addr

It sets the first address of the status area.

#### SLMP Network Num

It sets the network No.

#### SLMP PLC Num

It sets the PLC No.

#### SLMP Module I/O Num

It sets the target module's I/O number.

### SLMP Module Station Num

It displays the module station number.

### SLMP Timeout

It sets the waiting time before the returning of PLC's response.

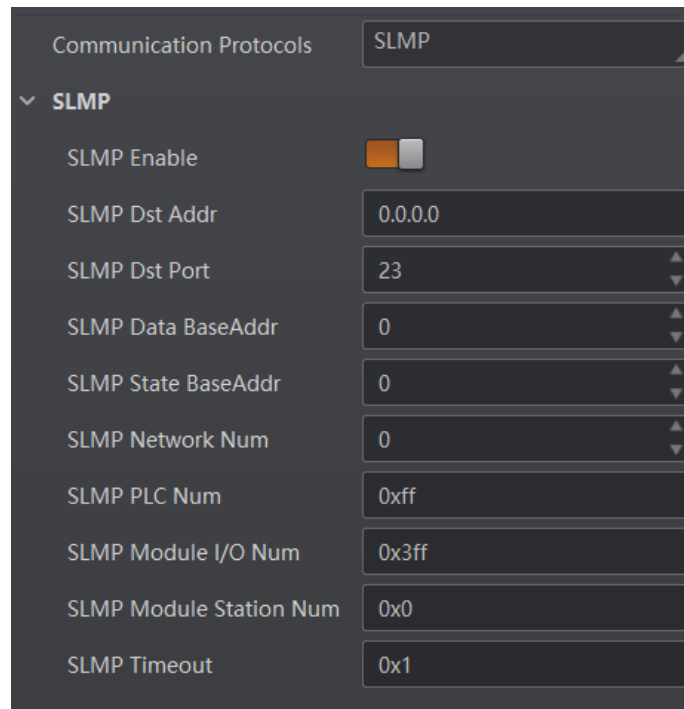


Figure 8-68 SLMP

## 8.9 User Set Customization

The Configuration Management module allows you to set and manage the user set. A user set is a group of parameter values with all the settings needed to control the device, and you can save, load and switch different user sets.

### Save Settings

If you have set the device parameters as desired, you can save them into the user set. Go to **Config Management** → **Save Settings**, and click **UserSet1**, **UserSet2**, or **UserSet3** to save the current device settings.

### Load Settings

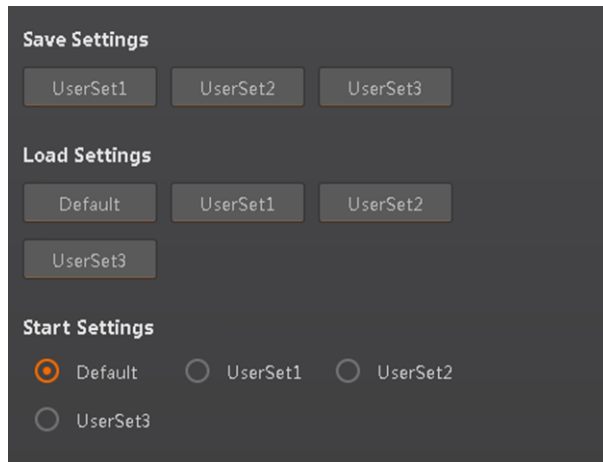
You can load the user set to restore the device to the saved group of parameter values again if required. Go to **Config Management** → **Load Settings**, and click **Default**, **UserSet1**, **UserSet2**, or **UserSet3** to load settings.

**Note**

The **Default** refers to restore the device parameter settings to the factory ones.

**Start Settings**

The selected user set will be automatically loaded after the device being powered on. For example, if you select **Default**, the device parameter settings will be restored to the factory settings.



**Figure 8-69 User Set Customization**

## 8.10 Statistics Information

The statistics information in the feature tree helps you to count data related with code reading.

**Note**

You need to set device mode as **Normal** before using this function.

Go to feature tree, find **Statistics Info.**, and select **Statistics Mode** according to actual demands. Two statistics modes are available:

**All Frames** means that the client software will display all data since the device is powered on.

**Latest Frames** means that the client software will display data of the last 10 frames.

Refer to the table below for specific parameters.

**Table 8-4 Parameter Description**

| Parameter Name      | Description   |
|---------------------|---|
| Total Frame Number  | The total frame quantity.                             |
| Read Frame Number   | The quantity of frames that have been read codes.     |
| Noread Frame Number | The quantity of frames that have not been read codes. |
| Read Rate           | It refers to the code reading ratio.                  |

| Parameter Name   | Description   |
|------------------|---|
| Algo Time Ave.   | The average time of algorithm, and the unit is ms.    |
| Algo Time Max.   | The max. time of algorithm, and the unit is ms.       |
| Algo Time Min.   | The min. time of algorithm, and the unit is ms.       |
| Read Time Ave.   | The average time of code reading, and the unit is ms. |
| Read Time Max.   | The max. time of code reading, and the unit is ms.    |
| Read Time Min.   | The min. time of code reading, and the unit is ms.    |
| Reset Statistics | Click <b>Execute</b> to reset statistics information. |

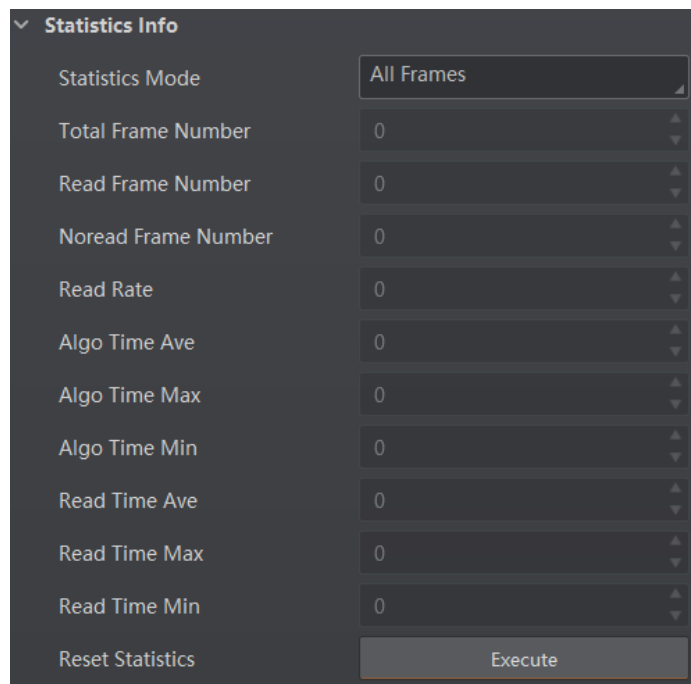


Figure 8-70 Statistics Information

## 8.11 Event Report

The diagnose event report function in the feature tree monitors memory and CPU usage rate, and let you know when there is a crash, higher CPU usage rate, insufficient memory, and other events. Go to feature tree, find **Diagnose Event Report**, and you can view related information as shown below. You can click **Execute** in **Reset Event** to clear all information.

Diagnose Event Report

|                   |                    |
|-------------------|--------------------|
| Event Code        | 0x30000004         |
| Event Name        | MemoryOver         |
| Event Report Time | 20201124_152610691 |
| Event Detail      | { "FreeMem" : 18,  |
| Reset Event       | Execute            |

Figure 8-71 Event Report

## Chapter 9 Device Operation

The device operation section introduces some basic device operations about how to start live view, acquisition and recording, add cross line in the image, split window, view reports, etc.

---



### Note

Connecting the device to the client software is required before device operation.

---

### 9.1 Live View

You can view the real-time image in the live view window.

Click  in live view window to start live view, or click  to stop.

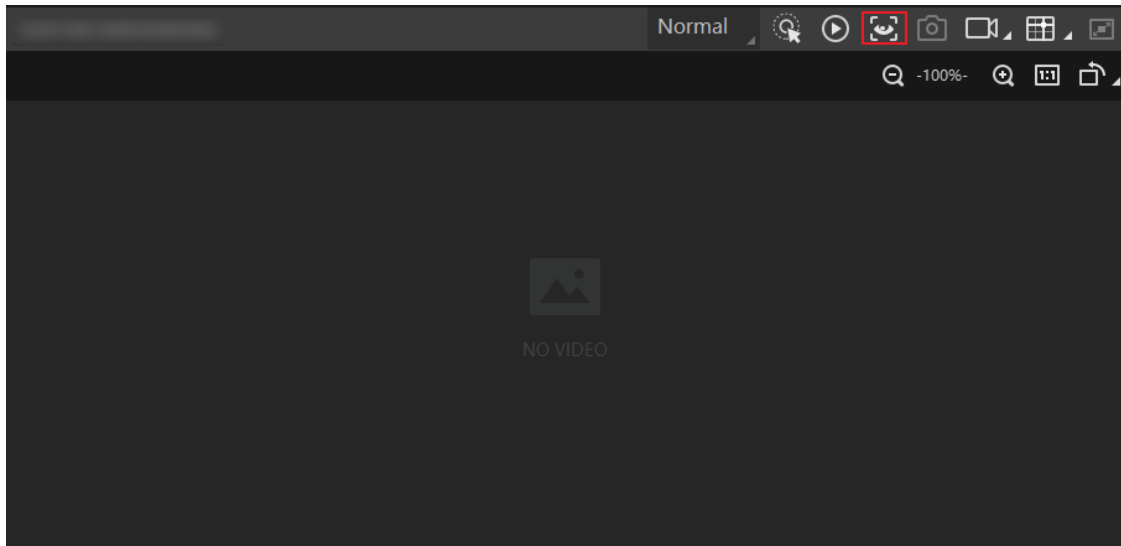




Figure 9-1 Live View

### 9.2 Enable Acquisition

Enabling acquisition allows the device to acquire the real-time stream.

Click  in live view window to start acquisition, or click  to stop. You can also right click the device on the device list, and click **Stop Acquisition** to stop acquiring streams.

---

### Note

Acquisition is still going on if you only stop live view.

---

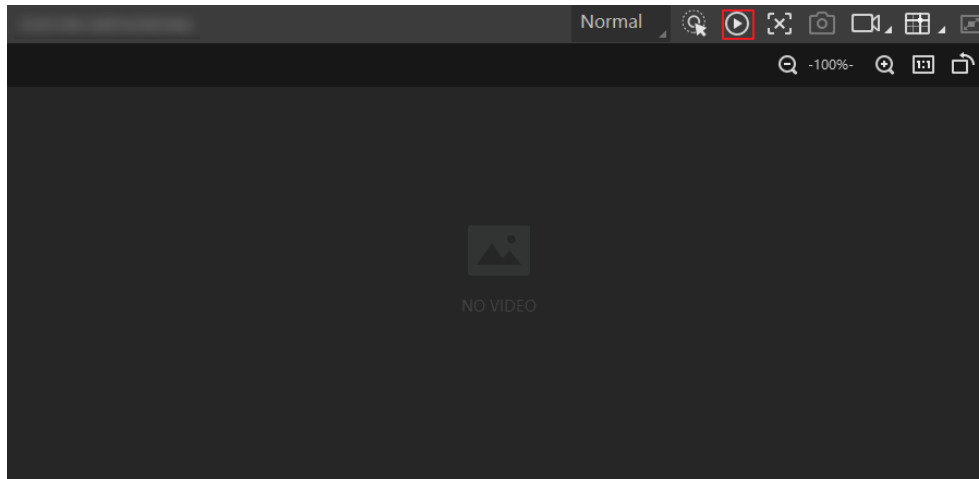


Figure 9-2 Enable Acquisition

### 9.3 Add Cross Line

During live view, you can add a cross line on the live view image to adjust the position of the object in the view.




Click  in live view window to add cross line, and click  (beside ) to open the editing window to set cross line parameters.







Figure 9-3 Add Cross Line

### 9.4 Start Recording

During live view, you can record video files and capture images continuously.

#### Note

Enabling acquisition is required before recording.

Click  in live view window to start recording, and click the icon again to stop. You can also click  (beside ) , and then click  to capture images of the live view continuously.

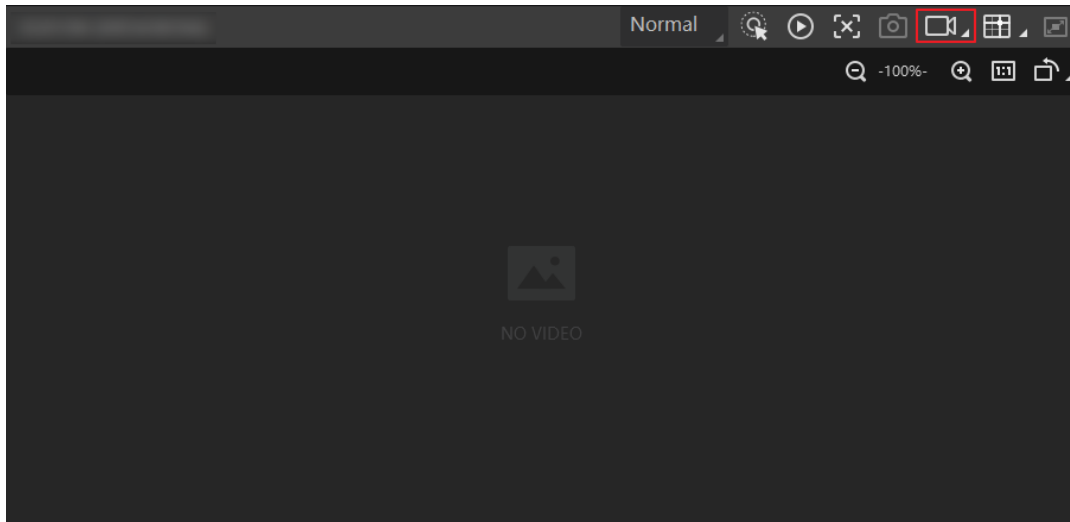



Figure 9-4 Start Recording

## 9.5 Split Window

The client software supports window division function that allows you to split the window into multiple-window mode to view the live view of multiple devices at the same time.

Click  in control toolbar to select window division mode. You can click **Custom** to customize window division as you desired.

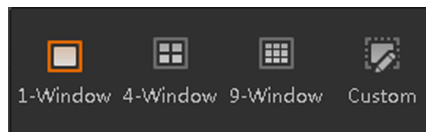



Figure 9-5 Split Window

## 9.6 View Reports

During acquisition or live view, you can view the reading status of the device.

Click  in control toolbar to open the statistics window to view the detailed information. **Read Code Images** refers to the number of the images on which the barcodes are read by the device. **Unread Code Images** refers to the number of the images on which the barcodes are not read by the device. **Read Rate** refers to the code reading rate.

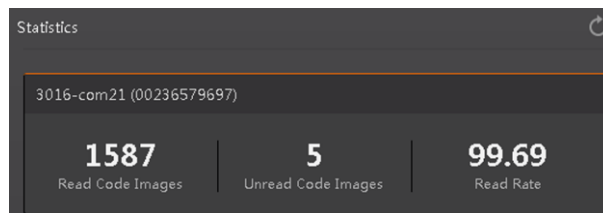

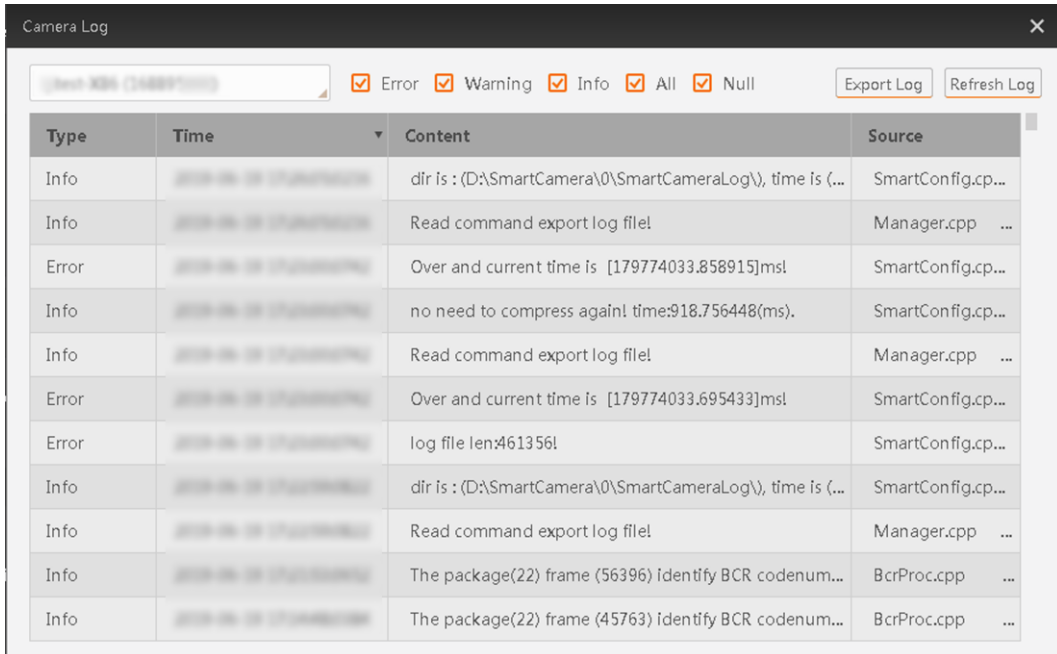


Figure 9-6 View Reports

## 9.7 View Log

You can view the device logs and export them to the local PC.

Click  in control toolbar to open the device log window, and you can view different types of logs, including device errors, warning, and informational log, etc.



| Type  | Time                    | Content   | Source            |
|-------|-------------------------|---|-------------------|
| Info  | 2019-06-28 17:44:00.000 | dir is : (D:\SmartCamera\0\SmartCameraLog\), time is (... | SmartConfig.cp... |
| Info  | 2019-06-28 17:44:00.000 | Read command export log file!                             | Manager.cpp ...   |
| Error | 2019-06-28 17:44:00.000 | Over and current time is [179774033.858915]ms!            | SmartConfig.cp... |
| Info  | 2019-06-28 17:44:00.000 | no need to compress again! time:918.756448(ms).           | SmartConfig.cp... |
| Info  | 2019-06-28 17:44:00.000 | Read command export log file!                             | Manager.cpp ...   |
| Error | 2019-06-28 17:44:00.000 | Over and current time is [179774033.695433]ms!            | SmartConfig.cp... |
| Error | 2019-06-28 17:44:00.000 | log file len:461356!                                      | SmartConfig.cp... |
| Info  | 2019-06-28 17:44:00.000 | dir is : (D:\SmartCamera\0\SmartCameraLog\), time is (... | SmartConfig.cp... |
| Info  | 2019-06-28 17:44:00.000 | Read command export log file!                             | Manager.cpp ...   |
| Info  | 2019-06-28 17:44:00.000 | The package(22) frame (56396) identify BCR codenum...     | BcrProc.cpp ...   |
| Info  | 2019-06-28 17:44:00.000 | The package(22) frame (45763) identify BCR codenum...     | BcrProc.cpp ...   |

Figure 9-7 View Log

## 9.8 Set Time

After enabling NTP time synchronization, the device will synchronize time according to the configured interval.

### Steps

1. Go to **Config Management**, and find **Timing**.
2. Click **Setting** and enable **NTP Enable**.
3. Set parameters according to actual demands.

### Note

Configure NTP server settings before using NTP time synchronization function.

4. Click **OK** after settings.

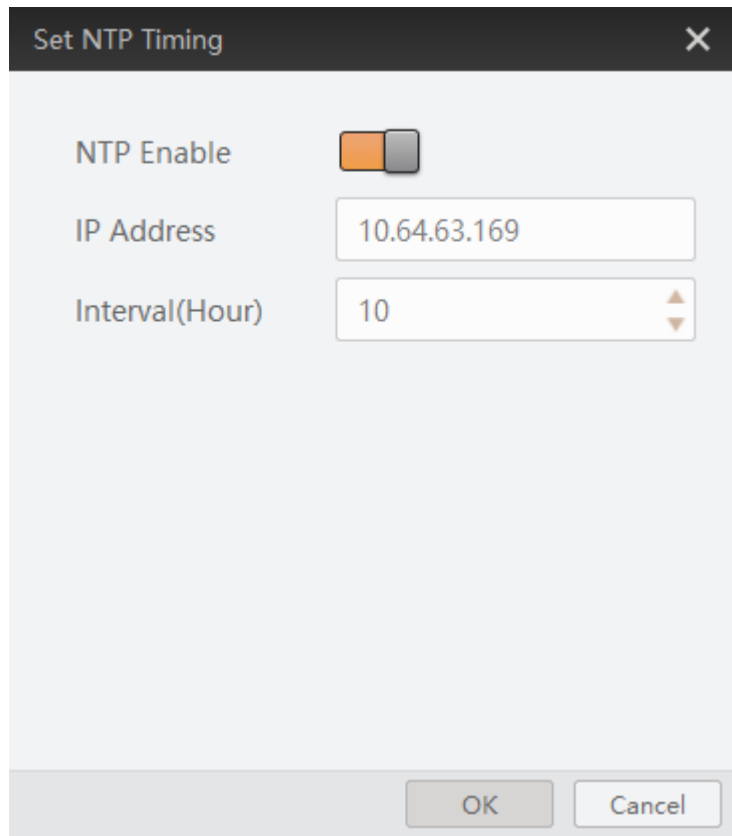


Figure 9-8 Set NTP Timing

## 9.9 Enable Device Auto Work

This function allows the device to automatically enter the operating status after being powered on.

You can go to **Config Management** → **Device Auto Work Enable**, and enable **Device Auto Work Enable**.

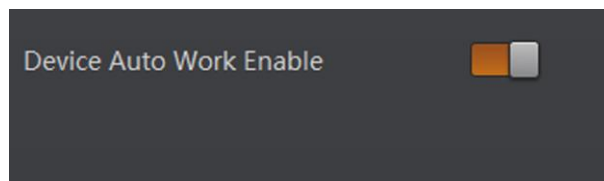


Figure 9-9 Enable Device Auto Work


## Chapter 10 Device Maintenance

### 10.1 Update Firmware

The device supports updating firmware via the client software.

#### Note

- Disconnect the device with client software.
- Please use the firmware package of the corresponding device model for upgrading.
- Do not power off the device or disconnect network during upgrading.
- The device will reboot automatically after updating the firmware.

Select the device to be updated in the device list, right click the device, and click **Firmware Update**. Click  to select update file from local PC, and click **Update** to update firmware.

#### Note

You can also go to **Tool** → **Firmware Updater** to update firmware.

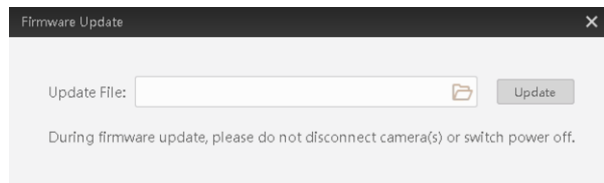
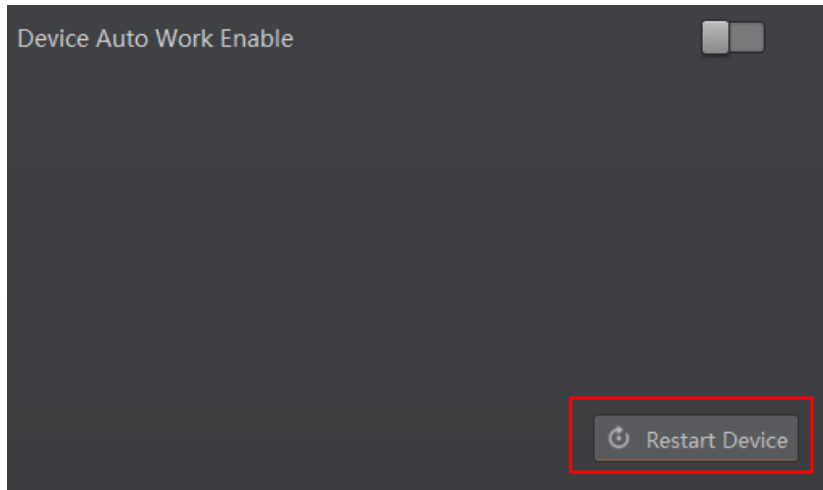


Figure 10-1 Update Firmware

### 10.2 Reboot Device

You can reboot the device via client software in 2 ways. Go to **Config Management**, and click **Restart Device**. Or, you can select the device to be rebooted in the device list, right click the device, and click **Device Reset**.



**Figure 10-2 Reboot Device**

## Chapter 11 FAQ (Frequently Asked Question)

### 11.1 Why the image is very dark?

#### **Problem**

All black or too dark during preview.

#### **Reason**

Too small adjustment value of exposure and gain, or the lens aperture is not opened enough.

#### **Solution**

Increase exposure and gain appropriately, or rotate the lens aperture to open largely.

### 11.2 Why the image's frame rate is very low in the live view?

#### **Problem**

Image incoherent/Low frame rate/Image tearing when adjusting the view preview.

#### **Reason**

- The network may be Fast Ethernet.
- Incorrect jumbo packet setting.

#### **Solution**

- Check whether the network transmission speed is 1 Gbps and NIC is the gigabit NIC, etc.
- Set jumbo packet value as 9 KB, or 9014 bytes.

### 11.3 Why there is no device listed after I run the IDMVS client software?

#### **Problem**

Run IDMVS client, there is no listed device.

#### **Reason**

- The device is powered off.
- Network exception.

### **Solution**

- Check the device power connection (observe whether the PWR light is solid blue or not), to make sure the device is powered up normally.
- Check the network connection (observe whether the LNK light is solid green or not and ACT light is flashing yellow or not) to make sure the device can be connected to the network normally. PC port and the device are in the same network segment.

## **11.4 Why there is no image in the live view?**

### **Problem**

No image in the live view.

### **Reason**

- Enabled trigger mode, but there is no trigger signal.
- Incorrect device mode settings, and no codes are recognized within the field of view.

### **Solution**

- Disable the trigger mode.
- Set the device mode as the test mode.

## **11.5 Why codes within the field of view cannot be recognized?**

### **Problem**

Codes within the field of view cannot be recognized.

### **Reason**

Correct code types are not selected in the **Algorithm Settings**, or incorrect settings in **Filter Rule**.

### **Solution**

- Go to **Algorithm Settings** → **Add Barcode**, and add different types of codes according to actual demands.
- Go to **Data Processing** → **Filter Rule**, and adjust settings in **Filter Rule** according to actual demands.

## Chapter 12 Revision History

**Table 12-1 Revision History**

| Version No. | Document No. | Date          | Revision Details   |
|-------------|--------------|---------------|--|
| V2.5.0      | UD27157B     | Feb. 9, 2022  | <ul style="list-style-type: none"> <li>● Modify section Set Code Reading ROI.</li> <li>● Modify section Set 1D Algorithm Parameter.</li> <li>● Modify section Set 2D Algorithm Parameter.</li> <li>● Modify section Set Filter Rule</li> <li>● Modify section Set Result Format.</li> </ul>  |
| V2.2.0      | UD23934B     | Apr. 29, 2021 | <ul style="list-style-type: none"> <li>● Modify section Appearance.</li> <li>● Modify section Installation Preparation.</li> <li>● Modify section Set Exposure.</li> <li>● Modify section Set Gain.</li> <li>● Modify section Set Light Source.</li> <li>● Modify section Set 1D Algorithm Parameter.</li> <li>● Modify section Set 2D Algorithm Parameter.</li> <li>● Add section Set Code Quantity Evaluation.</li> <li>● Add section Set Stack Code Algorithm Parameter.</li> <li>● Modify section Set Code Reading ROI.</li> <li>● Modify section Set Self-Adaptive Adjustment.</li> <li>● Add section Set Time.</li> </ul>  |
| V2.0.0      | UD22125B     | Nov. 25, 2020 | <ul style="list-style-type: none"> <li>● Add section Set Exposure.</li> <li>● Add section Set Gain.</li> <li>● Modify section Set Polling.</li> <li>● Modify section Set Lens Focus.</li> <li>● Modify section Add Barcode.</li> <li>● Modify section Set 1D Algorithm Parameter.</li> <li>● Modify section Set 2D Algorithm Parameter.</li> <li>● Modify section Set Code Reading ROI.</li> <li>● Add section Set Self-Adaptive Adjustment.</li> <li>● Add section Set and Execute Self Trigger Mode.</li> <li>● Modify section Set Event Source.</li> <li>● Modify section Set Filter Rule.</li> <li>● Modify section Set Result Format.</li> <li>● Add section Compare Control Settings.</li> <li>● Modify section Communication Settings.</li> <li>● Add section Statistics Information.</li> <li>● Add section Event Report.</li> </ul> |
| V1.0.0      | UD17611B     | Dec. 20, 2019 | Original version.  |



See Far, Go Further