



Wired Handheld Code Reader

User Manual

Legal Information

© 2023 Hangzhou Hikrobot Co., Ltd. All rights reserved.

About This Manual

The Manual includes instructions for using and managing the Product. Pictures, charts, images and all other information hereinafter are for description and explanation only. The information contained in the Manual is subject to change, without notice, due to firmware updates or other reasons. Please find the latest version of this Manual at the Hikrobot website (<https://en.hikrobotics.com/>). Please use this Manual with the guidance and assistance of professionals trained in supporting the Product.

Trademarks

HIKROBOT and other Hikrobot's trademarks and logos are the properties of Hikrobot in various jurisdictions. Other trademarks and logos mentioned are the properties of their respective owners.

Disclaimer

TO THE MAXIMUM EXTENT PERMITTED BY APPLICABLE LAW, THIS MANUAL AND THE PRODUCT DESCRIBED, WITH ITS HARDWARE, SOFTWARE AND FIRMWARE, ARE PROVIDED "AS IS" AND "WITH ALL FAULTS AND ERRORS". HIKROBOT MAKES NO WARRANTIES, EXPRESS OR IMPLIED, INCLUDING WITHOUT LIMITATION, MERCHANTABILITY, SATISFACTORY QUALITY, OR FITNESS FOR A PARTICULAR PURPOSE. THE USE OF THE PRODUCT BY YOU IS AT YOUR OWN RISK. IN NO EVENT WILL HIKROBOT BE LIABLE TO YOU FOR ANY SPECIAL, CONSEQUENTIAL, INCIDENTAL, OR INDIRECT DAMAGES, INCLUDING, AMONG OTHERS, DAMAGES FOR LOSS OF BUSINESS PROFITS, BUSINESS INTERRUPTION, OR LOSS OF DATA, CORRUPTION OF SYSTEMS, OR LOSS OF DOCUMENTATION, WHETHER BASED ON BREACH OF CONTRACT, TORT (INCLUDING NEGLIGENCE), PRODUCT LIABILITY, OR OTHERWISE, IN CONNECTION WITH THE USE OF THE PRODUCT, EVEN IF HIKROBOT HAS BEEN ADVISED OF THE POSSIBILITY OF SUCH DAMAGES OR LOSS.

YOU ACKNOWLEDGE THAT THE NATURE OF INTERNET PROVIDES FOR INHERENT SECURITY RISKS, AND HIKROBOT SHALL NOT TAKE ANY RESPONSIBILITIES FOR ABNORMAL OPERATION, PRIVACY LEAKAGE OR OTHER DAMAGES RESULTING FROM CYBER-ATTACK, HACKER ATTACK, VIRUS INFECTION, OR OTHER INTERNET SECURITY RISKS; HOWEVER, HIKROBOT WILL PROVIDE TIMELY TECHNICAL SUPPORT IF REQUIRED. YOU AGREE TO USE THIS PRODUCT IN COMPLIANCE WITH ALL APPLICABLE LAWS, AND YOU ARE SOLELY RESPONSIBLE FOR ENSURING THAT YOUR USE CONFORMS TO THE APPLICABLE LAW. ESPECIALLY, YOU ARE RESPONSIBLE, FOR USING THIS PRODUCT IN A MANNER THAT DOES NOT INFRINGE ON THE RIGHTS OF THIRD PARTIES, INCLUDING WITHOUT LIMITATION, RIGHTS OF PUBLICITY, INTELLECTUAL PROPERTY RIGHTS, OR DATA PROTECTION AND OTHER PRIVACY RIGHTS. YOU SHALL NOT USE THIS PRODUCT FOR ANY PROHIBITED END-USES, INCLUDING THE DEVELOPMENT OR PRODUCTION OF WEAPONS OF MASS DESTRUCTION, THE DEVELOPMENT OR PRODUCTION OF CHEMICAL OR BIOLOGICAL WEAPONS, ANY ACTIVITIES IN THE CONTEXT RELATED TO ANY NUCLEAR

EXPLOSIVE OR UNSAFE NUCLEAR FUEL-CYCLE, OR IN SUPPORT OF HUMAN RIGHTS ABUSES.

THE PERFORMANCE DATA IN THIS PUBLICATION IS BASED ON HIKROBOT'S INTERNAL RESEARCH/EVALUATION. ACTUAL DATA MAY VARY DEPENDING ON SPECIFIC CONFIGURATIONS AND OPERATING CONDITIONS AND HIKROBOT SHALL NOT BEAR THE CONSEQUENCES ARISING THEREFROM.

IN THE EVENT OF ANY CONFLICTS BETWEEN THIS MANUAL AND THE APPLICABLE LAW, THE LATTER PREVAILS.

Regulatory Information

Note

These clauses apply only to the products bearing the corresponding mark or information.

FCC Information

Please take attention that changes or modification not expressly approved by the party responsible for compliance could void the user's authority to operate the equipment.

FCC Compliance

This equipment has been tested and found to comply with the limits for a Class A digital device, pursuant to part 15 of the FCC Rules. These limits are designed to provide reasonable protection against harmful interference when the equipment is operated in a commercial environment. This equipment generates, uses, and can radiate radio frequency energy and, if not installed and used in accordance with the instruction manual, may cause harmful interference to radio communications. Operation of this equipment in a residential area is likely to cause harmful interference in which case the user will be required to correct the interference at his own expense.

FCC Conditions

This device complies with part 15 of the FCC Rules. Operation is subject to the following two conditions:

- This device may not cause harmful interference.
- This device must accept any interference received, including interference that may cause undesired operation.

EU Conformity Statement



This product and - if applicable - the supplied accessories too are marked with "CE" and comply therefore with the applicable harmonized European standards listed under the Directive 2014/30/EU(EMCD), Directive 2001/95/EC(GPSD) and Directive 2011/65/EU(RoHS).



2012/19/EU (WEEE directive): Products marked with this symbol cannot be disposed of as unsorted municipal waste in the European Union. For proper recycling, return this product to your local supplier

upon the purchase of equivalent new equipment, or dispose of it at designated collection points. For more information see: <http://www.recyclethis.info>



2006/66/EC (battery directive): This product contains a battery that cannot be disposed of as unsorted municipal waste in the European Union. See the product documentation for specific battery information. The battery is marked with this symbol, which may include lettering to indicate cadmium (Cd), lead (Pb), or mercury (Hg). For proper recycling, return the battery to your supplier or to a designated collection point. For more information see: <http://www.recyclethis.info>

Warning: This is a class A product. In a domestic environment this product may cause radio interference in which case the user may be required to take adequate measures.



KC Mark Certification

Class A: The device is advised to note that as a seller or a business user (Class A) Devices and intended for use outside the Home area.

A급 기기: 이 기기는 업무용(A급) 전자파적합기기로서 판매자 또는 사용자는 이 점을 주의하시기바라며, 가정 외의 지역에서 사용하는 것을 목적으로 합니다.

Symbol Conventions

The symbols that may be found in this document are defined as follows.

Symbol	Description
 Danger	Indicates a hazard with a high level of risk, which if not avoided, will result in death or serious injury.
 Caution	Indicates a potentially hazardous situation which, if not avoided, could result in equipment damage, data loss, performance degradation, or unexpected results.
 Note	Provides additional information to emphasize or supplement important points of the main text.

Available Model

This manual is applicable to the wired handheld code reader.

Contact Information

Hangzhou Hikrobot Co., Ltd.

E-mail: tech_support@hikrobotics.com

Website: <https://en.hikrobotics.com/>

Contents

Chapter 1 Safety Instruction	1
1.1 Safety Claim	1
1.2 Safety Instruction	1
1.3 Electromagnetic Interference Prevention.....	2
Chapter 2 Overview	4
2.1 Introduction.....	4
2.2 Key Features.....	4
Chapter 3 Appearance	5
Chapter 4 Device Connection and Basic Operation.....	10
4.1 Accessories	10
4.2 Device Connection.....	10
4.3 Basic Operation	12
Chapter 5 Client Software Installation and Operation	14
5.1 Install Client Software	14
5.2 Set PC Environment	15
5.2.1 Turn off Firewall for Fast Ethernet Type Device.....	15
5.2.2 Set PC Network for Fast Ethernet Type Device.....	15
5.2.3 Check USB Drive for USB Type Device	16
5.3 Set Device Network.....	17
5.4 Connect Device to Client Software	17
Chapter 6 Client Software Layout.....	18
Chapter 7 Device Mode Settings	20
Chapter 8 Setting Codes	21
8.1 Introduction.....	21
8.2 Enable/Disable Setting Codes.....	21
8.3 Set Setting Codes of Code Type	22
8.4 Set Setting Codes of Code Reading Mode	25
8.5 Set Setting Codes of Code Reading Quantity	26
8.6 Set Setting Codes of Data Processing.....	28

8.7 Set Setting Codes of Aiming System	30
8.8 Set Setting Codes of Light Source.....	31
8.9 Set Setting Codes of Buzzer.....	32
8.10 Set Setting Codes of Vibration.....	34
8.11 Set Setting Codes of USB Communication.....	35
8.12 Set Setting Codes of Serial Port	36
8.13 Set Setting Codes of Sending Device Information	38
8.14 Set Setting Codes of Self Trigger	39
8.15 Set Setting Codes of Management	39
Chapter 9 Device Settings	40
9.1 Feature Tree Introduction	40
9.2 Code Reading Mode Settings	41
9.3 Prompt Settings.....	42
9.3.1 Set Buzzer	42
9.3.2 Set Vibrator	42
9.4 Image Quality Settings	43
9.4.1 Set Image	43
9.4.2 Set Exposure	44
9.4.3 Set Gain	45
9.4.4 Set Light Source.....	45
9.4.5 Set Mirror X.....	47
9.4.6 Set Test Pattern.....	47
9.5 Code Algorithm Settings	47
9.5.1 Add Code	47
9.5.2 Set Algorithm Parameter	48
9.6 Signal Input Settings	48
9.6.1 Set and Execute Hardware Tigger	49
9.6.2 Set and Execute Response Tigger.....	50
9.6.3 Set and Execute Self Tigger	50
9.6.4 Set and Execute Software Tigger	50
9.7 Code Reading Result Settings.....	51

9.7.1 Set Filter Rule	51
9.7.2 Set Result Format	53
9.8 Communication Settings.....	56
9.8.1 Smart SDK.....	56
9.8.2 USB.....	57
9.8.3 TCP Client.....	57
9.8.4 Serial	58
9.8.5 FTP	58
9.8.6 HTTP.....	59
9.8.7 TCP Server.....	60
9.8.8 Profinet	60
9.8.9 MELSEC	60
9.8.10 Ethernet/IP	61
9.8.11 ModBus	62
9.8.12 UDP	63
9.8.13 Fins.....	63
9.8.14 SLMP.....	65
9.9 User Set Customization.....	66
Chapter 10 Device Operation	67
10.1 Live View.....	67
10.2 Enable Acquisition	67
10.3 Add Cross Line.....	68
10.4 Start Recording.....	68
10.5 Split Window	69
10.6 View Reports	69
10.7 View Log	70
10.8 Set Time.....	70
10.9 Enable Device Auto Work.....	71
Chapter 11 Device Maintenance.....	72
11.1 Update Firmware	72
11.2 Reboot Device.....	72

Chapter 12 FAQ (Frequently Asked Question)73

- 12.1 Why there is no buzzer sound and the indicator is unlit after the device is connected? 73**
- 12.2 Why the device does not read codes after powering on and getting triggered? .73**
- 12.3 Why the device does not read codes after connecting to client software and getting triggered?..... 73**
- 12.4 Why there is no buzzer sound after the device reads codes successfully? 73**
- 12.5 Why configuring setting codes failed though there is buzzer sound? 74**
- 12.6 Why only a few codes read successfully on the batch code reading mode? 74**
- 12.7 Why the image is very dark during the live view? 74**

Appendix A ASCII Table..... 75

Chapter 1 Safety Instruction

The safety instructions are intended to ensure that the user can use the device correctly to avoid danger or property loss. Read and follow these safety instructions before installing, operating and maintaining the device.

1.1 Safety Claim

- To ensure personal and device safety, when installing, operating, and maintaining the device, follow the signs on the device and all safety instructions described in the manual.
- The note, caution and danger items in the manual do not represent all the safety instructions that should be observed, but only serve as a supplement to all the safety instructions.
- The device should be used in an environment that meets the design specifications, otherwise it may cause malfunctions, and malfunctions or component damage caused by non-compliance with relevant regulations are not within the scope of the device's quality assurance.
- Our company will not bear any legal responsibility for personal safety accidents and property losses caused by abnormal operation of the device.

1.2 Safety Instruction

Caution:

- In the use of the device, you must be in strict compliance with the electrical safety regulations of the nation and region.
- Install the device in accordance with the installation method mentioned in this manual, and makes sure that the device is firmly fixed.
- It is forbidden to install the indoor device in an environment where it may be exposed to water or other liquids. If the device is damp, it may cause fire and electric shock hazard.
- If the device emits smoke, odor or noise, please turn off the power and unplug the power cord immediately, and contact the dealer or service center in time.
- Use the power adapter provided by the official manufacturer. The power adapter must meet the Limited Power Source (LPS) requirements. For specific requirements, please refer to the device's technical specifications.
- Do not cover the device's plug or outlet for disconnecting power supply.
- It is strictly forbidden to install, wire or maintain the device when it is powered on, otherwise there is a danger of electric shock.
- Protective measures like wearing safety goggles are required when installing, maintaining and debugging the device.
- Avoid aiming the lens at strong light (such as lighting, sunlight, or laser beams, etc.),

otherwise the image sensor will be damaged.

- If it is necessary to clean the device, use a damp paper towel or a soft clean cloth to moisten a little pure water, gently wipe off the dust, and do not use alcohol-based corrosive solutions. Make sure to power off the device and unplug the power socket when cleaning.
- If the device does not work properly, please contact your dealer or the nearest service center. Never attempt to disassemble the device yourself (we shall not assume any responsibility for problems caused by unauthorized repair or maintenance).
- Please dispose of the device in strict accordance with the relevant national or regional regulations and standards to avoid environmental pollution and property damage.

Note:

- Check whether the device's package is in good condition, whether there is damage, intrusion, moisture, deformation, etc. before unpacking.
- Check the surface of the device and accessories for damage, rust, bumps, etc. when unpacking.
- Check whether the quantity and information of the device and accessories are complete after unpacking.
- Store and transport the device according to the storage and transport conditions of the device, and the storage temperature and humidity should meet the requirements.
- It is strictly prohibited to transport the device in combination with items that may affect or damage the device.
- Please read the manual and safety instructions carefully before installing the device.
- The device should not be placed with exposed flame sources, such as lighted candles.
- Quality requirements for installation and maintenance personnel:
 - Qualification certificate or working experience in weak current system installation and maintenance, and relevant working experience and qualifications. Besides, the personnel must possess the following knowledge and operation skills.
 - The basic knowledge and operation skills of low voltage wiring and low voltage electronic circuit connection.
 - The ability to comprehend the contents of this manual.

1.3 Electromagnetic Interference Prevention

- Make sure that the shielding layer of cables is intact and 360° connected to the metal connector when using shielded cables.
- Do not route the device together with other equipment (especially servo motors, high-power devices, etc.), and control the distance between cables to more than 10 cm. Make sure to shield the cables if unavoidable.
- The control cable of the device and the power cable of the industrial light source must be wired separately to avoid bundled wiring.
- The power cable, data cable, signal cable, etc. of the device must be wired separately. Make sure to ground them if the wiring groove is used to separate the wiring and the wiring groove is metal.

- During the wiring process, evaluate the wiring space reasonably, and do not pull the cables hard, so as not to damage the electrical performance of the cables.
- If the device is powered on and off frequently, it is necessary to strengthen the voltage isolation, and consider adding a DC/DC isolation power supply module between the device and the adapter.
- Use the power adapter to supply power to the device separately. If centralized power supply is necessary, make sure to use a DC filter to filter the power supply of the device separately before use.
- The unused cables of the device must be insulated.
- When installing the device, if you cannot ensure that the device itself and all equipment connected to the device are well grounded, you should isolate the device with an insulating bracket.
- To avoid the accumulation of static electricity, ensure that other equipment (such as machines, internal components, etc.) and metal brackets on site are properly grounded.
- Make sure that the connector metal barrier of the device is well connected to the PC and other chassis, and if necessary, copper foil should be used to enhance the grounding effect.
- During the installation and use of the device, high voltage leakage must be avoided.
- Use a figure-eight bundle method if the device cable is too long.
- When connecting the device and metal accessories, they must be connected firmly to maintain good conductivity.
- Use a shielded network cable to connect to the device. If you use a self-made network cable, make sure that the shielding shell at the aviation head is well connected to the aluminum foil or metal braid of the shielding cable.

Chapter 2 Overview

2.1 Introduction

The wired handheld code reader adopts code reading algorithm to provide good decoding capability for DPM, and can read different types of one-dimensional and two-dimensional codes, and output codes rapidly. It is applicable to industries of PCB, new energy, consumer electronics, semiconductor, automobile parts, etc.

2.2 Key Features

- Adopts code reading algorithm to provide good decoding capability.
- Provides good robustness to read codes with spots, defects and low contrast radio.
- Supports continuous code reading, batch code reading for improving code reading efficiency.
- Supports multiple communication protocols, including TCP Client, Serial, FTP, Profinet, etc.

 **Note**

- Key features may differ by device models.
 - Refer to the specification of the device for detailed parameters.
-

Chapter 3 Appearance

Note

Appearance here is for reference only. Refer to the device's specification for detailed dimension information.

Currently, the wired handheld code reader has four types of appearance (type I, type II, type III, and type IV), as shown below.

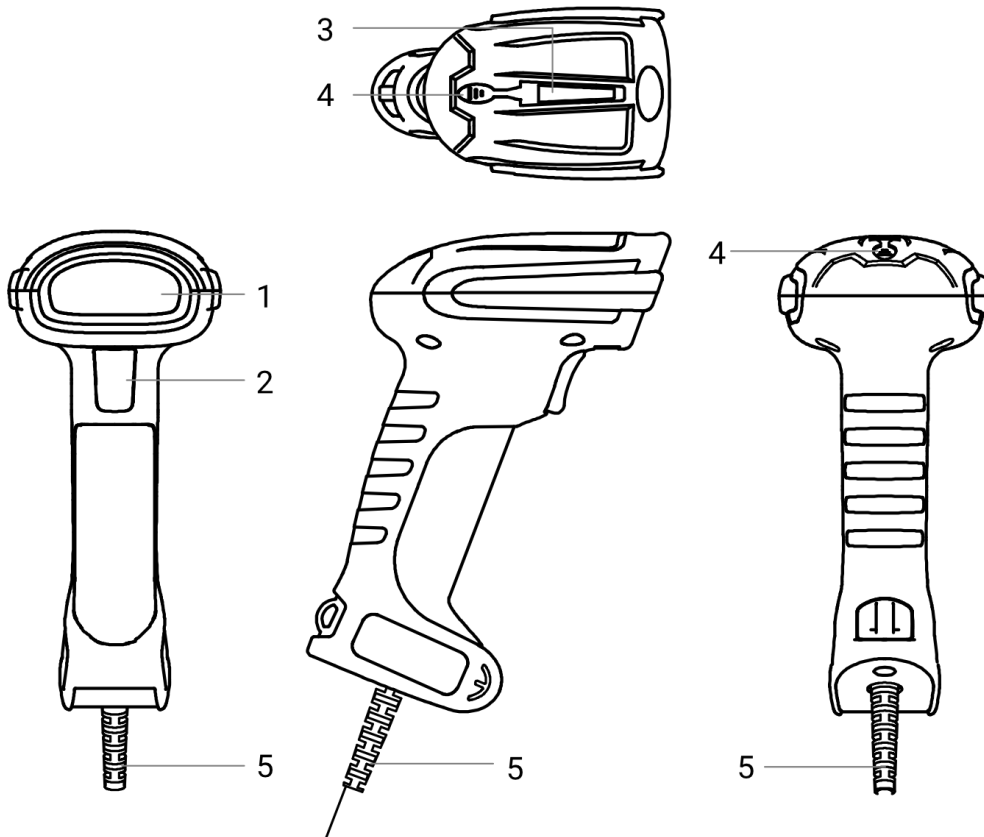

Figure 3-1 Appearance (Type I)

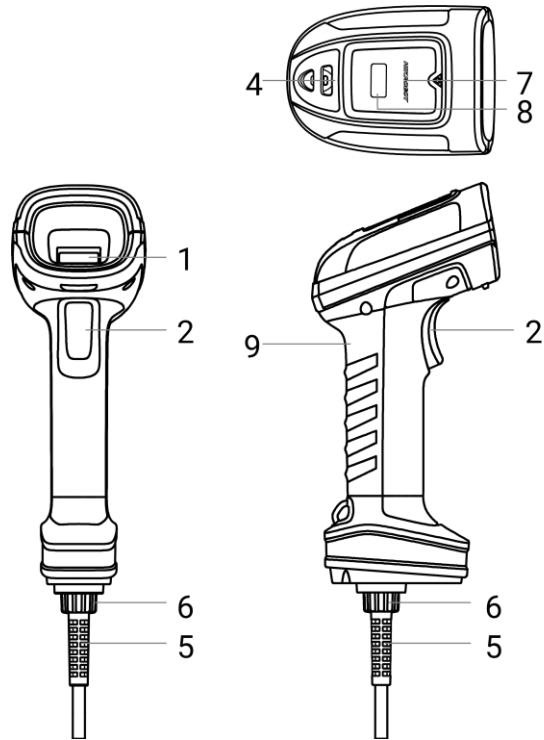

Figure 3-2 Appearance (Type II)

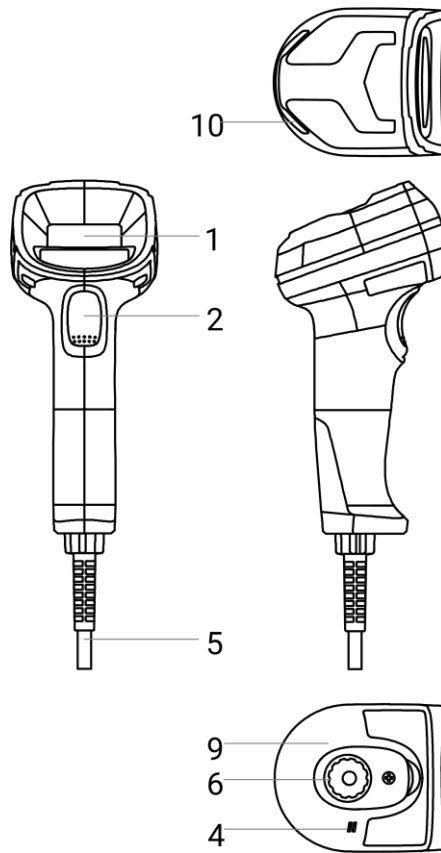

Figure 3-3 Appearance (Type III)

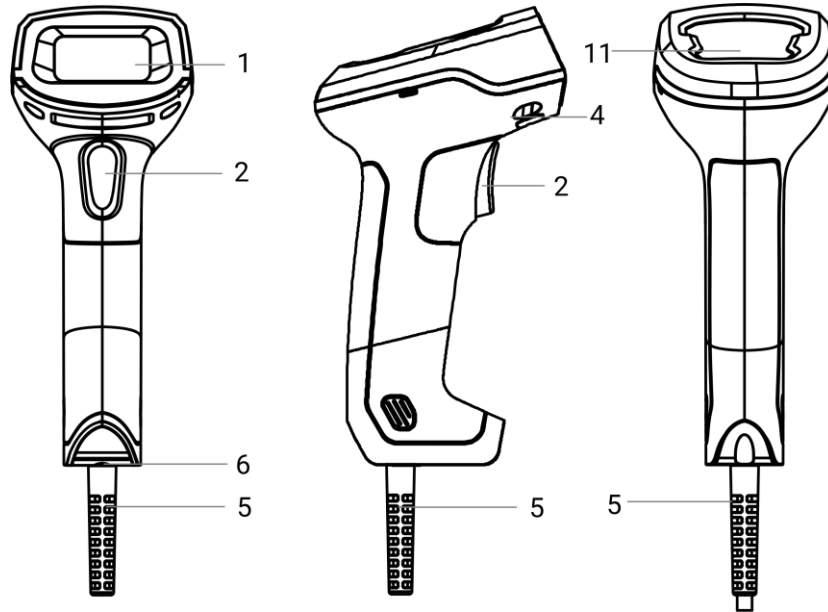





Figure 3-4 Appearance (Type IV)

Table 3-1 Component Description

No.	Name	Description
1	Reading Window	<p>It is used to acquire images, and consists of sensor, lens, supplement light, aiming system, etc.</p> <p>Note The components of reading window may differ by device models.</p>
2	Tigger Switch	<p>Press the trigger switch to trigger the device once when the device is in an external trigger mode.</p> <p>Note The type III device supports restoring to factory settings via pressing the trigger switch. Press and hold the trigger switch for 10 sec, and release it when hearing beep sound. Press and hold the trigger switch for 3 sec when you hear beep sound again to restore the device to factory settings.</p>
3	Status Indicator (Type I Device)	<p>It indicates the type I device's status.</p> <ul style="list-style-type: none"> • The indictor is solid red during the device is powered on, is solid green after being powered on and network/USB is not connected, and is solid orange after network/USB is connected. • The indicator is in red color (lasting 0.5 sec) when it does not recognize codes, and is in green color (lasting 0.5 sec) when the device recognizes codes.

No.	Name	Description
		<ul style="list-style-type: none"> • The indicator is flashing orange when the device is updating its firmware, is solid red lasting 3 sec until restating when updating fails, and is solid green lasting 3 sec until restating when updating succeeds.
4	Buzzer	<p>It indicates the device's operation status via buzzer.</p> <ul style="list-style-type: none"> • The buzzer beeps three times after the device is powered on. • The buzzer beeps once when the device reads codes successfully. • The buzzer beeps twice when the device reads setting codes successfully. • The buzzer beeps once with duration of 3 sec when the device fails to update firmware. <p> Note The buzzer's duration when the device fails to update firmware may differ by device models.</p>
5	Cable	<p>It provides power, transmits data and has function of Ethernet and serial port.</p> <p> Note The function of cables may differ by device models.</p>
6	8/10-Pin Connector	<p>It is used to transmit data and provide power.</p> <p> Note</p> <ul style="list-style-type: none"> • Only type II and type III devices have a 10-pin connector. • Only type IV device has an 8-pin connector.
7	Power Indicator (Type II Device)	<p>It indicates the power status and firmware updating status of the type II device.</p> <ul style="list-style-type: none"> • The power indicator is solid red during the device is powered on, is solid green after being powered on and network/USB is not connected, and is solid orange after being powered on and network/USB is connected. • The power indicator is flashing orange when the device is updating its firmware, is solid red lasting 3 sec until restating the device when updating fails, and is solid green lasting 3 sec until restating the device when updating succeeds.
8	Status Indicator (Type II Device)	<p>It indicates the type II device's status.</p> <ul style="list-style-type: none"> • The indicator is solid red when the device starts up and unlit after being powered on. • The indicator is in green color (lasting 0.5 sec) when the device recognizes codes, and is in red color (lasting 0.5 sec) when the device does not recognize codes.

No.	Name	Description
9	Vibrator	<p>It indicates the device's operation status via vibration.</p> <ul style="list-style-type: none"> ● The device vibrates once for 0.3 sec when it finishes starting. ● The device vibrates once for 0.3 sec when it recognize codes. ● The device vibrates twice (duration 300 ms, interval 300 ms) when it recognizes setting codes. <p> Note Only type II and type III devices have a vibrator.</p>
10	Indicator (Type III Device)	<p>It indicates the type III device's operation status.</p> <ul style="list-style-type: none"> ● The indicator is solid red during the device is powered on, is solid yellow after being powered on and network/USB is not connected, and is unlit after network/USB is connected. ● The indicator is flashing yellow when the device is updating its firmware, is solid red lasting 3 sec when updating fails, and is solid green lasting 3 sec when updating succeeds. ● The indicator is in green color when the device recognizes codes, and is in red color when the device does not recognize codes. ● The indicator is in green color when the device recognizes setting codes. ● The indicator is flashing green when the device transmits data.
11	Status Indicator (Type IV Device)	<p>It indicates the type IV device's status.</p> <ul style="list-style-type: none"> ● The indicator is solid green when the device starts up, and unlit after USB is connected. ● The indicator is in green color when the device recognizes codes, and is unlit when it does not recognize codes. ● The indicator is flashing green when the device is updating its firmware, is solid green lasting 3 sec until restating when updating fails, and is unlit lasting 3 sec until restating when updating succeeds.

Chapter 4 Device Connection and Basic Operation

4.1 Accessories

You need to prepare following accessories before device connection and installation.

Table 4-1 Accessories

No.	Name	Quantity	Description
1	Cable	1	It is used to wire the device and provide power, and is included in the package. <ul style="list-style-type: none"> • USB type device: You should use USB connection cable. • Fast Ethernet type: You should use Ethernet connection cable.
2	Power Adapter	1	You should select suitable power adapter according to the device's power supply and consumption. You need to purchase separately. <p> Note Power adapter is required when the USB type device uses power adapter to provide power.</p>

4.2 Device Connection

The device each has two types, including USB type and fast Ethernet type. Refer to sections below to connect the corresponding device type.

 **Note**

The images of cables below are for reference only.

USB Type

 **Note**

Make sure to use correct type of USB cables when connecting the device.

- **USB Cable for Type I Device**

The USB cable for type I device is shown below, and the cable supports USB3.0 interface. Connect the USB interface of the cable to the PC to connect the device.

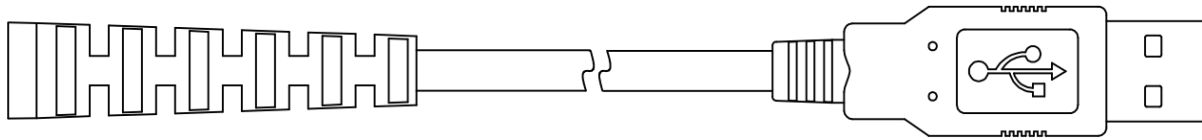

Figure 4-1 USB Cable for Type I Device

● **USB Cable for Type II and Type III Devices**

The USB cable for type II and type III devices is shown below, and the cable supports USB2.0 interface. Connect the 10-pin connector to the device, connect the USB to the PC, and connect the DC power connector to the power adapter.

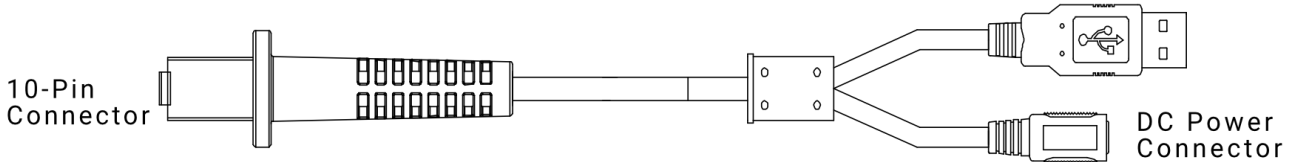

Figure 4-2 USB Cable for Type II and Type III Devices

Note

The USB2.0 interface on the cable supports providing power supply. Thus, you can use the device without connecting to the power adapter.

● **USB Cable for Type IV Device**

The USB cable for type IV is shown below. Connect the 8-pin connector to the device, and connect the USB of the cable to the PC for data transmission or power supply.

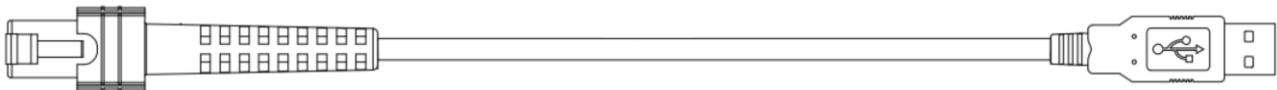

Figure 4-3 USB Cable for Type IV Device

Fast Ethernet Type

Note

Connecting the RS-232 connector of the cable to the PC is required if you want to use the serial port function.

● **Cable for Type I Device**

The cable for type I device is shown below. Connect the RJ45 connector to the PC or a switch for image debugging or data transmission, and connect the DB9 connector to the power adapter.

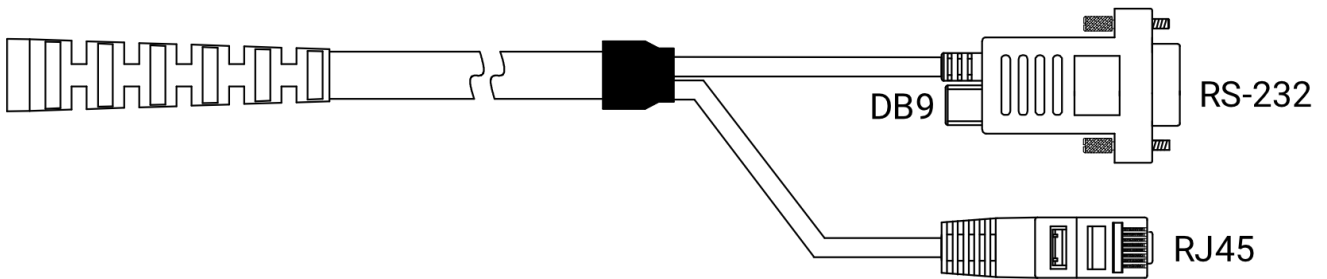

Figure 4-4 Cable for Type I Device

● **Cable for Type II and Type III Devices**

The cable for type II and type III devices is shown below. Connect the 10-pin connector to the device, connect the DB9 connector to the power adapter, and connect the RJ45 connector to the PC or a switch for image debugging or data transmission.

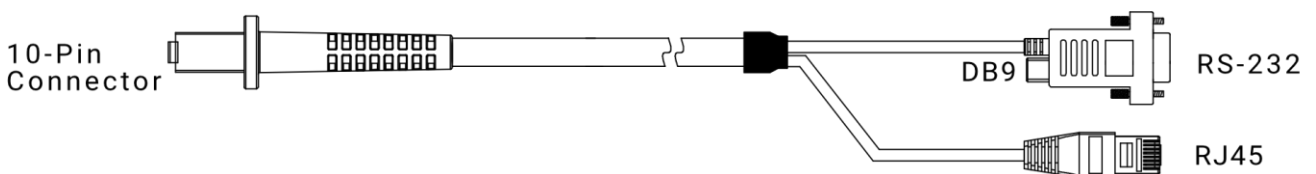



Figure 4-5 Cable for Type II and Type III Devices

4.3 Basic Operation

Before you start: Make sure that the device connection is done correctly. The code reading operation of the device is as follow.

Note

- Before using other setting codes, you need to scan **Enable Setting Codes** first to activate the function of setting codes.
- After the device is connected to the IDMVS client software, you need to click  on the control toolbar to start acquiring images before code reading.

Steps

1. Set the device's parameters via the IDMVS client software or reading corresponding setting codes.

Note

- You can set the device's parameters after connecting it to the client software.
- You can set the device's parameters via letting the device aim at corresponding setting codes, and press the trigger switch. Refer to section **Setting Codes** for details. If the device beeps twice with vibration and meanwhile its indicator turns green from red, and then parameters are configured successfully, and then release the trigger switch.

2. Move the device and let it aim at codes that need to be read, and press the trigger switch.

3. Release the trigger switch after the device beeps once with vibration and meanwhile its indicator turns green from red. The device sends decoded data to the PC.

Chapter 5 Client Software Installation and Operation

5.1 Install Client Software

IDMVS is a client software for device configuration and remote operations.

Steps

Note

- Check the Windows version. The client software is compatible with 32/64-bit Windows XP/7/10.
 - It is recommended to install the latest version of the client software, and you can download the installation package from <https://en.hikrobotics.com/>.
 - The USB type device supports IDMVS V2.3.0 and above only that has integrated USB drive.
 - The graphic user interface may differ by versions of client software you use.
-

1. Double click the installation package to start installing the client software.
2. Select the language.
3. Read and check **Terms of the License Agreement**.
4. Click **Start Setup**.
5. Select installation directory and click **Next**.

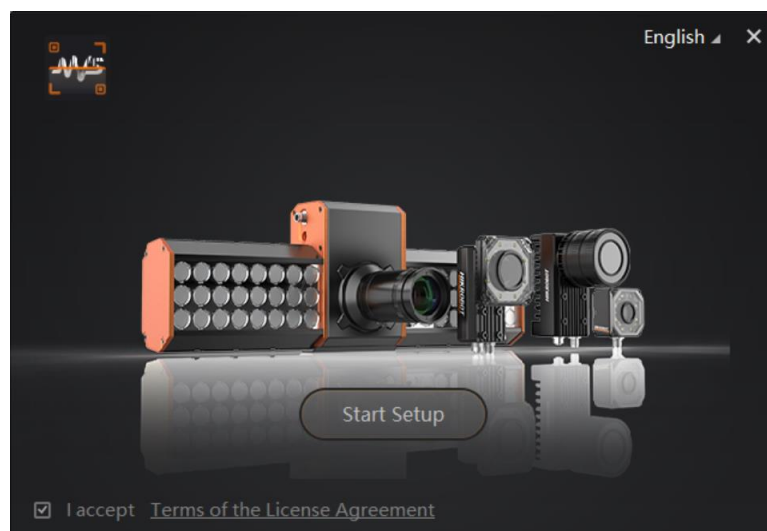

Figure 5-1 Installation Interface

6. Finish the installation according to the interface prompts.

5.2 Set PC Environment

To ensure stable client running and data transmission, you are recommended to set PC environment. For the fast Ethernet type device, you need to turn off the firewall and set PC network. For the USB type device, you need to check the USB drive on the PC.

5.2.1 Turn off Firewall for Fast Ethernet Type Device

Steps

Note

For different Windows versions, the path name or interface may differ. Please refer to the actual condition.

1. Go to Windows Firewall.
 - Windows XP system: Click **Start** → **Control Panel** → **Security Center** → **Windows Firewall**.
 - Windows 7 system: Click **Start** → **Control Panel** → **Windows Firewall**.
 - Windows 10 system: Click **Start** → **Control Panel** → **System and Security** → **Windows Defender Firewall**.
2. Click **Turn Windows Defender Firewall on or off** on the left.
3. Select **Turn off Windows Defender Firewall (not recommended)**.

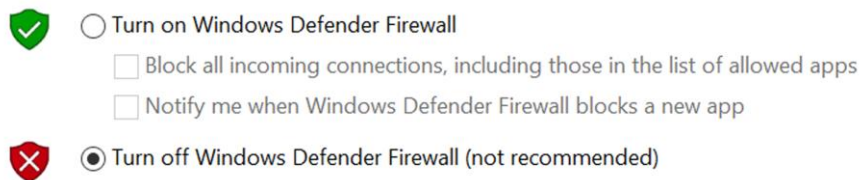

Figure 5-2 Windows Defender Firewall

4. Click **OK**.

5.2.2 Set PC Network for Fast Ethernet Type Device

To ensure stable data transmission and normal communication between the PC and the device via client software, you need to set the PC network and make sure that they are in the same network segment.

Steps

Note

For different Windows versions, the specific setting path and interface may differ. Please refer to the actual condition.

1. Go to PC network settings page: **Start** → **Control Panel** → **Network and Internet** → **Network and Sharing Center** → **Change adapter settings**.
2. Select NIC and set the IP obtainment mode.
 - Select **Obtain an IP address automatically** to get an IP address of the PC automatically.
 - Or select **Use the following IP address** to set an IP address for the PC manually.

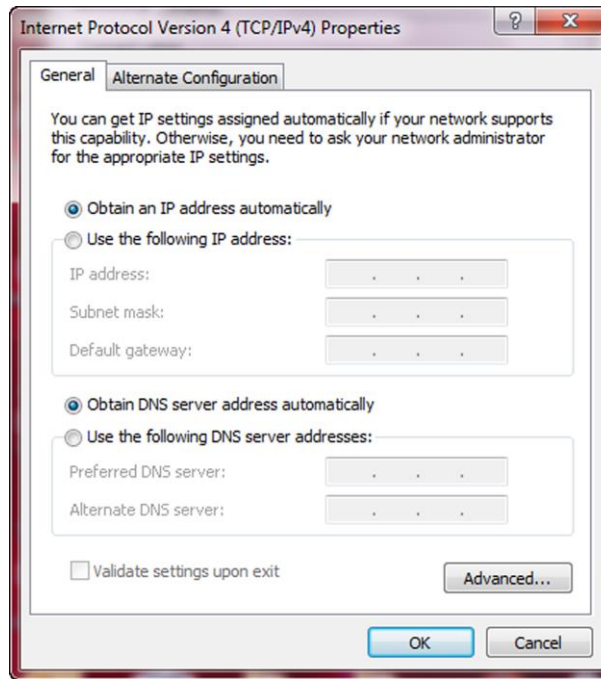

Figure 5-3 Set PC Network

5.2.3 Check USB Drive for USB Type Device

Checking the USB drive on the PC is required before using the USB type device. After connecting the USB type device to the PC, the Windows system will automatically detect a new hardware device and install its corresponding drive.

Go to **Device Manager** by either pressing Win+X or right-clicking on the Windows menu button, and locate and expand the **Network adapters** to check the drive.

Note

You can use the drive management tool to reinstall the USB drive if the installation is failed.

5.3 Set Device Network

You can set and operate the device in the client software only when the device is in the same network segment with the PC where the client software is installed.

Steps

1. Double click the client software to run it.
2. Click  to find the device.
3. Right click the device to be connected.
4. Click **Modify IP**.
5. Set the IP address of the device in the same network segment with the PC.

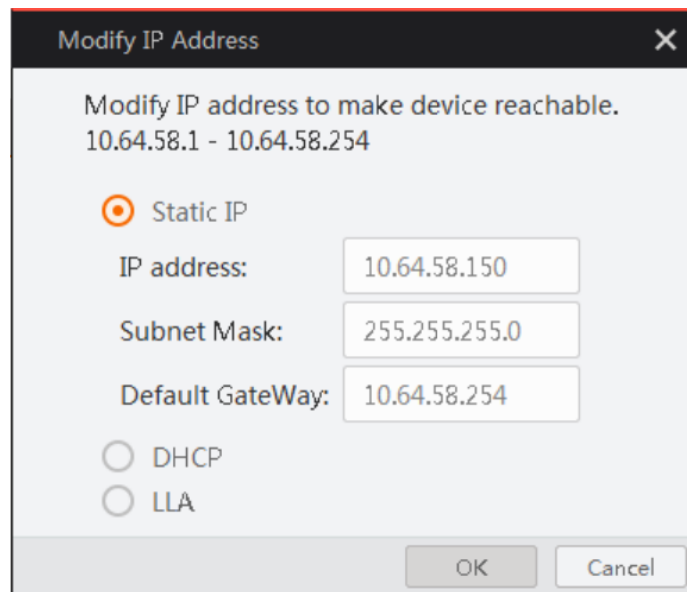

Figure 5-4 Modify IP Address

6. Click **OK**.

5.4 Connect Device to Client Software

Make sure that your device IP address is in the same network segment with the PC where you installed the client software before connecting the device to it.

Double click the device in the device list, or click  to connect the device to the client.

Chapter 6 Client Software Layout

After connecting to the device, the client software can read the device information and display it.

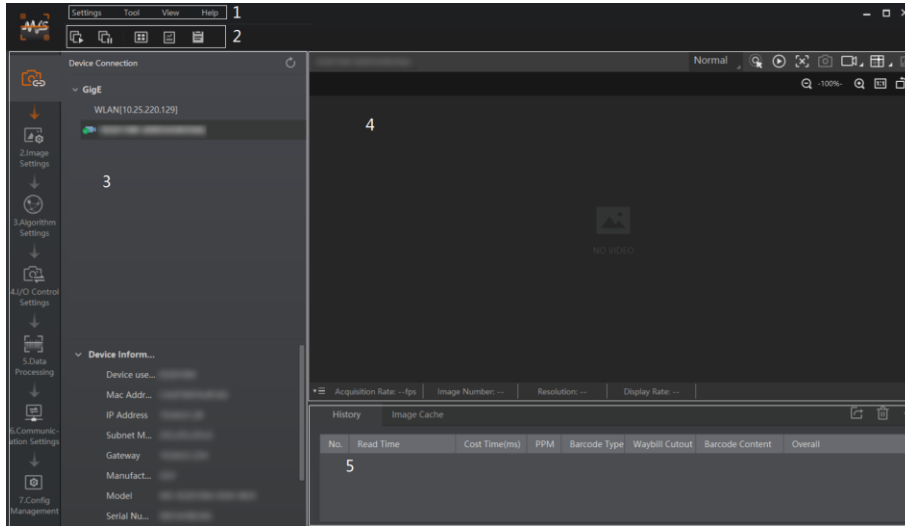

Figure 6-1 Main Window

Note

- The specific interfaces of the client software may differ by its versions.
- Refer to the user manual of the client software for detailed introductions and operations.

Table 6-1 Description of Main Window

No.	Name	Description
1	Menu Bar	The menu bar displays function modules, including Settings , Tool , View , and Help .
2	Control Toolbar	The control toolbar provides quick operations for the device. You can click different icons to start or stop batch acquisition, change window layout, view statistics information, and device log.
3	Device Configuration Area	You can connect or disconnect device, set parameters, and modify device IP address in this area.
4	Live View Window	This area displays the acquisition images and algorithm reading result in real-time. You can click different icons to capture and save image, record, etc.
5	History Record and Image Cache	This area displays different barcode information read by the device in real-time. You can also set image cache here.

You can set device parameters in device configuration area.

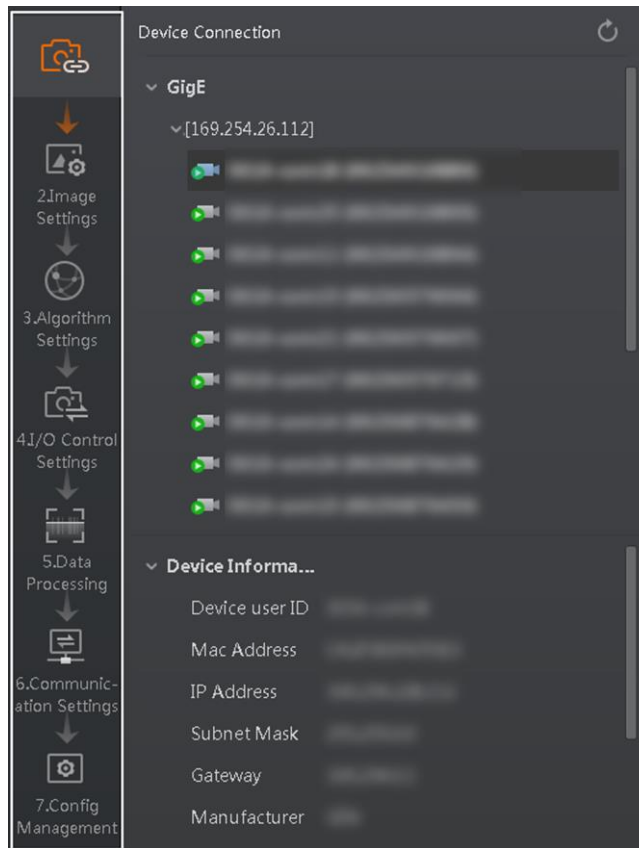

Figure 6-2 Device Configuration Area

Table 6-2 Configuration Area Description

No.	Module Name	Description
1	Device Connection	You can connect or disconnect device, modify device IP address, view device information, etc.
2	Image Settings	You can set image parameters, light parameters, etc.
3	Algorithm Settings	You can add different barcodes, set barcode number, etc.
4	I/O Control Settings	You can set parameters related with input and output.
5	Data Processing	You can set filter rule for output result.
6	Communication Settings	You can select different communication protocols, and set related parameters for output result.
7	Configuration Management	You can save and load user parameters, and restart the device.

Chapter 7 Device Mode Settings

The device supports 3 types of operating modes, including **Test**, **Normal**, and **Raw**. You can select different modes in live view window according to actual demands.

Note

- Stopping the real-time acquisition is required before selecting modes.
- You need to set device mode as **Normal** before specific device settings. Otherwise, the device parameters may be different.

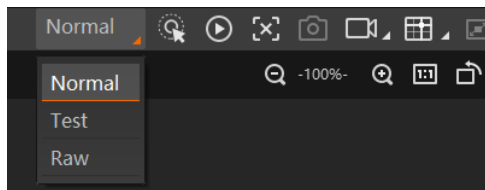

Figure 7-1 Select Device Mode

Table 7-1 Device Mode Description

Device Mode	Description
Test Mode	It is used during device debugging. The device outputs images that are acquired in real-time, and displays code information.
Normal Mode	It is used during device normal operation. After reading code in image, the device outputs image and code information.
Raw Mode	It is used during testing image data. The device outputs raw data and displays code information.

You can click  in live view window to view images and code reading effect. If the effect is not very good, you can adjust related parameters like exposure time, gain, etc. in the **Image Settings** area.



Figure 7-2 Code Reading

Chapter 8 Setting Codes

8.1 Introduction

The device supports configuring parameters via reading special codes that are called setting codes. Here we introduce common setting codes.

 **Note**

Before using other setting codes, you need to scan **Enable Setting Codes** first to activate the function of setting codes.



Figure 8-1 Setting Codes Introduction

Table 8-1 Device Mode Description



No.	Description
1	It is the code part of the setting code. After reading this part, the device can finish the corresponding parameter settings.
2	**stands for the default settings.
3	It is the content of setting codes.

Via reading setting codes, the device can set enable/disable settings, set code type, set code reading mode, set quantity of code reading, set data processing, set aiming system, set light source, set buzzer, set vibration, set USB communication, set serial port, etc.

8.2 Enable/Disable Setting Codes

Before using other setting codes, you need to scan **Enable Setting Codes** first to activate the function of setting codes. Scan **Disable Setting Codes** to exit setting codes function.

Table 8-2 Enable/Disable Setting Codes

Function	Setting Codes	Function	Setting Codes
Enable Setting Codes		Disable Setting Codes	







8.3 Set Setting Codes of Code Type













The device can be set what code type to be read via reading specific setting codes. Currently, the device supports Code 39, Code 93, Code 128, CodeBar, ITF 25, ITF 14, EAN 8, EAN 13, UPCA, UPCE, QR Code, and Data Matrix.













Note





The supported code types may differ by device models.

Table 8-3 Set Setting Codes of Code Type

Function	Setting Codes	Function	Setting Codes
Enable All 1D Codes		Disable All 1D Codes	
Enable All 2D Codes		Disable All 2D Codes	
Enable Code 39		Disable Code 39	

Function	Setting Codes	Function	Setting Codes
Enable Code 128		Disable Code 128	
Enable Code 93		Disable Code 93	
Enable CodeBar		Disable CodeBar	
Enable ITF 14		Disable ITF 14	
Enable ITF 25		Disable ITF 25	
Enable EAN 8		Disable EAN 8	





Function	Setting Codes	Function	Setting Codes
Enable EAN 13		Disable EAN 13	
Enable UCPA		Disable UCPA	
Enable UCPE		Disable UCPE	
Enable QR Code		Disable QR Code	
Enable Data Matrix		Disable Data Matrix	
Enable Micro QR Code		Disable Micro QR Code	

Function	Setting Codes	Function	Setting Codes
Enable AZTEC Code		Disable AZTEC Code	
Enable PDF 417		Disable PDF 417	

8.4 Set Setting Codes of Code Reading Mode

The device supports setting different code reading modes via scanning setting codes, including common mode, accurate mode, continuous mode, and batch mode.

Table 8-4 Set Setting Codes of Code Reading Mode

Function	Setting Codes	Function	Setting Codes
Common Mode		Accurate Mode	
Continuous Mode		Batch Mode	

8.5 Set Setting Codes of Code Reading Quantity

You can set the device's code reading quantity via scanning the specific setting codes as shown below.

Steps

1. Read setting codes of editing quantity of code reading.



Figure 8-2 Edit Quantity of Code Reading

2. Read the corresponding digital codes according to actual demands.
-

Note











- The quantity of code reading is related with code reading mode.
 - If the code reading mode is batch mode and the quantity of code reading is smaller than or equal to 21, you should scan the digital code of tens digit first, and then scan the single digit. If the quantity of code reading is single digit, the digital code of tens digit is 0. For example, if the quantity of code reading is 12, scan the digital code of 1 first, and then scan 2.
 - If the code reading mode is continuous mode, the quantity of code reading is not limited. You should scan the digital code in the first place, and then scan the digital code in the second place, etc. For example, if the quantity of code reading is 530, scan 5 first, and then 3, and 0 at last.
-

3. Read the setting codes of saving to save the parameter settings.



Figure 8-3 Setting Codes of Saving

Table 8-5 Digital Codes

Function	Setting Codes	Function	Setting Codes
Digital Code 0		Digital Code 1	
Digital Code 2		Digital Code 3	
Digital Code 4		Digital Code 5	
Digital Code 6		Digital Code 7	
Digital Code 8		Digital Code 9	





8.6 Set Setting Codes of Data Processing

You can set the device's outputted code results via scanning the specific setting codes as shown below.

Steps



1. Read setting codes of enabling prefix or suffix.

Table 8-6 Setting Codes of Enabling Prefix or Suffix

Function	Setting Codes	Function	Setting Codes
Enable Prefix		Disable Prefix	
Enable Suffix		Disable Suffix	

2. Read setting codes of editing prefix or editing suffix.

Table 8-7 Setting Codes of Editing Prefix or Suffix

Function	Setting Codes	Function	Setting Codes
Edit Prefix		Edit Suffix	

3. Set prefix and suffix characters according to actual demands, find the corresponding hexadecimal code value in ASCII table (see **Appendix A ASCII Table** for details), and read the corresponding digital codes. For example, if the defined prefix and suffix content is *, the corresponding ASCII code is 2a. Use to the device to read the digital code 2 and digital code a in turn.

Note

Up to ten setting codes can be read.

Table 8-8 Setting Codes of a to f













Function	Setting Codes	Function	Setting Codes
Digital Code a		Digital Code b	
Digital Code c		Digital Code d	
Digital Code e		Digital Code f	

Table 8-9 Setting Codes of Data Processing

Function	Setting Codes	Function	Setting Codes
Enable Stop Text		Disable Stop Text	
Edit Stop Text		Enable Newline	
Disable Newline		Enable Enter	

Function	Setting Codes	Function	Setting Codes
Disable Enter		--	--

4. Read the setting codes of saving to save the parameter settings.











Figure 8-4 Setting Codes of Saving

8.7 Set Setting Codes of Aiming System

The aiming system is used to locate codes in the field of view to help read codes easily. The setting codes of aiming system can enable, disable, delay or set delay time of the aiming system.

Table 8-10 Set Setting Codes of Aiming System

Function	Setting Codes	Function	Setting Codes
Enable Aiming System		Disable Aiming System	
Enable Aiming System Delay		Disable Aiming System Delay	

Function	Setting Codes	Function	Setting Codes
Set Delay Time 1 s		Set Delay Time 2 s	
Set Delay Time 5 s		Set Delay Time 10 s	





8.8 Set Setting Codes of Light Source







The setting codes of light source can enable or disable the light source, set polling interval, etc. After enabling **Light Polling**, you can let red and while light sources polling alternately in accordance with configured interval when code reading succeeds or before ending trigger.

 **Note**

- By default, the polling interval is 2 s.
- The supported setting codes of light source may differ by device models.

Table 8-11 Set Setting Codes of Light Source

Function	Setting Codes	Function	Setting Codes
Enable Lighting Polling		Disable Lighting Polling	
Set Polling Interval 500 ms		Set Polling Interval 1 s	

Function	Setting Codes	Function	Setting Codes
Set Polling Interval 2 s		Set Polling Interval 5 s	
Set Polling Interval 10 s		Enable White Light	
Disable White Light		Enable Red Light	
Disable Red Light		--	--













8.9 Set Setting Codes of Buzzer





The setting codes of buzzer can enable or disable the buzzer function, set its duration, etc.

Note

The supported setting codes of buzzer may differ by device models.

Table 8-12 Set Setting Codes of Buzzer





Function	Setting Codes	Function	Setting Codes
Enable Buzzer When Device Powers On		Disable Buzzer When Device Powers On	
Enable Buzzer When Reading Codes		Disable Buzzer When Reading Codes	
Set Buzzer Duration 1 s When Starting		Set Buzzer Duration 2 s When Starting	
Set Buzzer Duration 3 s When Starting		Set Buzzer Duration 50 ms When Reading Codes	
Set Buzzer Duration 100 ms When Reading Codes		Set Buzzer Duration 150 ms When Reading Codes	
Set Buzzer Duration 40 ms		Set Buzzer Duration 80 ms	





Function	Setting Codes	Function	Setting Codes
Set Buzzer Duration 120 ms		Set Buzzer Duty Ratio 25%	
Set Buzzer Duty Ratio 50%		Set Buzzer Duty Ratio 75%	

8.10 Set Setting Codes of Vibration

The setting codes of vibration can enable or disable the vibration function, set its duration, etc.

Table 8-13 Set Setting Codes of Vibration

Function	Setting Codes	Function	Setting Codes
Enable Vibration		Disable Vibration	
Set Vibration Duration 100 ms		Set Vibration Duration 200 ms	

Function	Setting Codes	Function	Setting Codes
Set Vibration Duration 300 ms		Set Vibration Duration 500 ms	
Set Vibration Duration 1 s		Set Vibration Duration 2 s	



8.11 Set Setting Codes of USB Communication









The setting codes of USB communication can enable or disable the USB communication function, set baud rate, etc.

 **Note**

- Only the USB type device supports the USB communication.
- By default, the device’s communication is USB keyboard. By reading specific setting codes, the device’s communication method can be switched to USB CDC.
- After switching communication method, the device will restart.

Table 8-14 Set Setting Codes of USB Communication

Function	Setting Codes	Function	Setting Codes
Enable USB Communication		Disable USB Communication	

Function	Setting Codes	Function	Setting Codes
USB HID Communication Mode		USB CDC Communication Mode	
Set Baud Rate as 4800		Set Baud Rate as 9600	
Set Baud Rate as 19200		Set Baud Rate as 38400	
Set Baud Rate as 57600		Set Baud Rate as 115200	













8.12 Set Setting Codes of Serial Port

The setting codes of serial port can enable or disable serial port function, set the baud rate, parity bit, and stop bit.

 **Note**

Only the fast Ethernet type device supports serial port function.

Table 8-15 Set Setting Codes of Serial Port





Function	Setting Codes	Function	Setting Codes
Enable Serial Port Function		Disable Serial Port Function	
Set Baud Rate as 4800		Set Baud Rate as 9600	
Set Baud Rate as 19200		Set Baud Rate as 38400	
Set Baud Rate as 57600		Set Baud Rate as 115200	
Set None Parity		Set Odd Parity	
Set Even Parity		Set Stop Bit 1	

Function	Setting Codes	Function	Setting Codes
Set Stop Bit 2			

8.13 Set Setting Codes of Sending Device Information

The device can send its information to the PC via reading specific setting codes, and the device information includes name, version, algorithm version, hardware version, serial number, etc.

Table 8-16 Set Setting Codes of Sending Device Information

Function	Setting Codes	Function	Setting Codes
Send Device Name		Get Device Version	
Get Hardware Version		Get Algorithm Version	
Get Serial Number		--	--

8.14 Set Setting Codes of Self Trigger

The setting codes of self trigger can let the device trigger according to configured trigger time interval and times when the device is acquiring image data.





Figure 8-5 Set Setting Codes of Self Trigger

8.15 Set Setting Codes of Management

The setting codes of management can save or initialize user parameters, and restart the device.

Table 8-17 Set Setting Codes of Management

Function	Setting Codes	Function	Setting Codes
Save		Initialize User Parameters	
Restart Device			

Chapter 9 Device Settings

9.1 Feature Tree Introduction

Note

The feature tree may differ by device models.

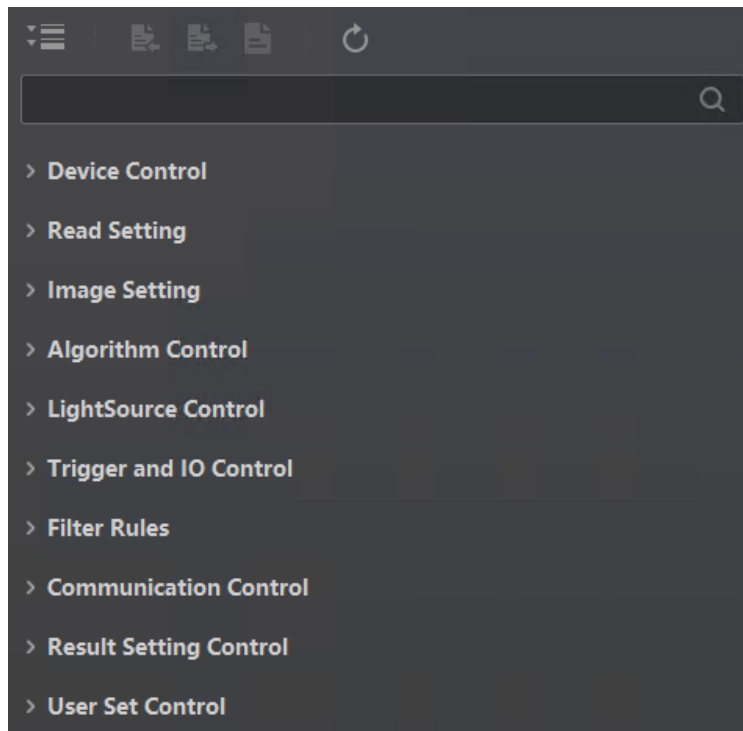

Figure 9-1 Feature Tree

Table 9-1 Feature Tree Description

No.	Module Name	Description
1	Device Control	You can view device information, edit its name, restart it, etc.
2	Read Setting	You can set the device mode and select code types.
3	Image Setting	You can set exposure, gain, Gamma, frame rate, etc.
4	Algorithm Control	You can set algorithm parameters of 1D codes and 2D codes.
5	Light Source Control	You can select the device's light source type and set parameters.

No.	Module Name	Description
6	Trigger and IO Control	You can set parameters related with input and output.
7	Filter Rules	You can set filter rule for output result.
8	Communication Control	You can select different communication protocols, and set related parameters for output result.
9	Result Setting Control	You can set parameters for output information.
10	User Set Control	You can save and load user parameters, and restart the device.

9.2 Code Reading Mode Settings

The device supports different code reading modes, including common mode, accurate mode, continuous mode, and batch mode.

Steps

1. Right click the device in **Device Connection**, and click **Feature Tree**.
2. Go to **Trigger and IO Control** → **Read Code Method**, and select it according to actual demands.

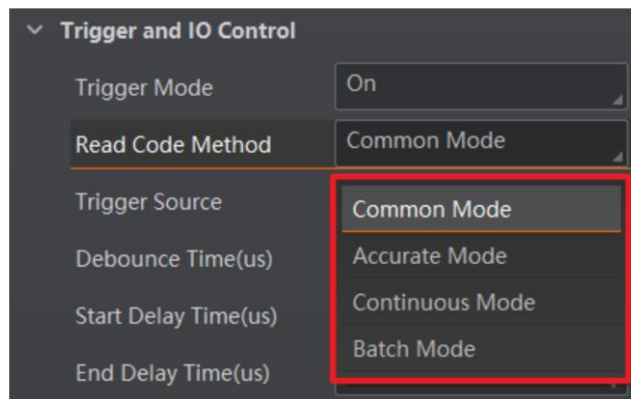

Figure 9-2 Code Reading Mode Settings

Table 9-2 Parameters Description

Code Reading Mode	Description
Common Mode	It reads codes that are closest to the cross laser center only. The code reading process ends if codes are read successfully or the trigger switch is released.
Accurate Mode	It reads codes containing the cross laser center in the code area only. The code reading process ends if codes are read successfully or the trigger switch is released.

Code Reading Mode	Description
Continuous Mode	It reads codes containing the cross laser center in the code area only. The device reads codes continuously when the trigger switch is pressed and ends reading when the switch is switched.
Batch Mode	It can read multiple codes when the trigger switch is pressed. After code reading is finished, the result will be packaged and outputted. The code reading process ends if expected code quantity is reached or exceeded, code reading timed out, valid frame quantity is reached, or the trigger switch is released.

9.3 Prompt Settings

Note

The specific parameters may differ by device models and firmware versions.

The device's buzzer and vibrator can be configured via the client software.

9.3.1 Set Buzzer

Go to **Tigger and IO Control**, you can set buzzer parameters of the device after reading codes successfully.

- Buzzer Enable: If it is enabled, you can set buzzer parameters of the device after reading codes successfully.
- Buzzer Duration: It sets the output duration of the buzzer, and unit is ms.
- Buzzer Frequency: It sets output frequency of the buzzer, and unit is hz.

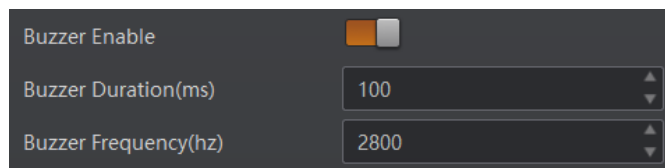

Figure 9-3 Set Buzzer

9.3.2 Set Vibrator

Go to **Tigger and IO Control**, you can set vibrator parameters of the device after reading codes successfully.

- Vibrator Enable: If it is enabled, you can set vibrator parameters of the device after reading codes successfully.
- Bcr Vibrator Duration (ms): It sets the output duration of the vibrator, and unit is ms.

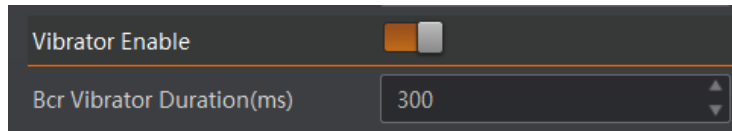

Figure 9-4 Set Vibrator

9.4 Image Quality Settings

This section introduces how to set image related parameters of the device via client software.

Note

For different models of the device, the specific parameters may differ, and the actual device you purchased shall prevail.

9.4.1 Set Image

You can set different image parameters like exposure time, gain, Gamma, and acquisition frame rate in image parameters interface.

Note

- Make sure you have select the device to be set in Device Connection before setting image parameters.
 - For specific parameter range like exposure time, gain and acquisition frame rate, refer to the device's specification for details.
-

Exposure Time

You can increase exposure time to improve image brightness.

Note

To some extent, increasing exposure time will reduce acquisition frame rate, and impact image quality.

Gain

You can increase gain to improve image brightness.

Note

To some extent, increasing gain will create more image noises, and impact image quality.

Gamma

Gamma allows you to adjust the image contrast. It is recommended to reduce Gamma to increase brightness in dark background.

Acquisition Frame Rate

Acquisition frame rate refers to the image number that is acquired by the device per second.



Figure 9-5 Set Image

9.4.2 Set Exposure

The device supports two types of exposure modes, including off and continuous. Refer to the table below for details.

Steps

1. Right click the device in **Device Connection**, and click **Feature Tree**.
2. Go to **Image Setting** → **Exposure Auto**, and select it according to actual demands.

Table 9-3 Exposure Mode

Exposure Auto	Description
Off	The device exposures according to the value configured by the user in Exposure Time (μs) .
Continuous	The device adjusts the exposure time continuously according to the image brightness.

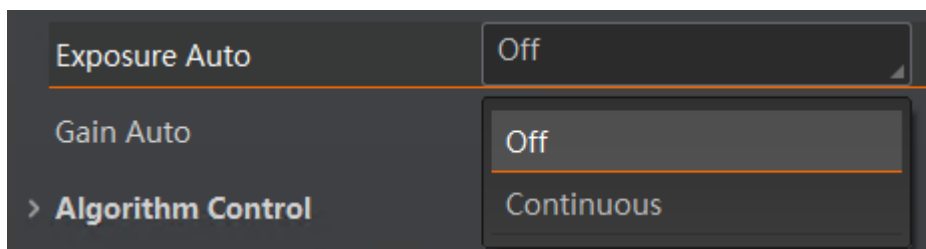

Figure 9-6 Set Exposure

9.4.3 Set Gain

The device supports two types of gain modes, including off and continuous. Refer to the table below for details.

Steps

1. Right click the device in **Device Connection**, and click **Feature Tree**.
2. Go to **Image Setting** → **Gain Auto**, and select it according to actual demands.

Table 9-4 Gain Mode

Gain Auto	Description
Off	The device adjust gain according to the value configured by the user in Gain (dB) .
Continuous	The device adjusts gain continuously according to the image brightness.

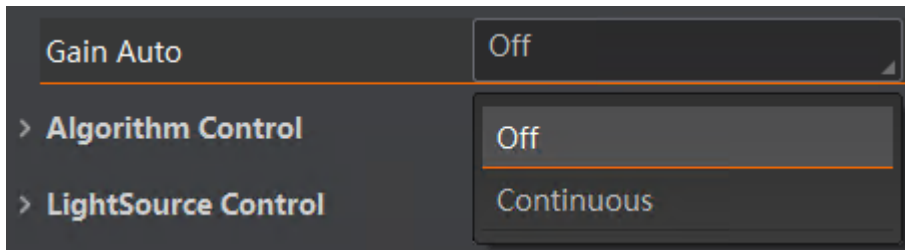

Figure 9-7 Set Gain

9.4.4 Set Light Source

Light source control allows you to enable the device’s aiming system and light source, and set related parameters according to actual demands.

Note

- Light source parameters may differ by device models.
- Make sure you have selected the device to be set in **Device Connection** before setting light source parameters.

Type II Devices

Regarding the type II device, you can set the following parameters.

Laser Enable

It enables or disables the device’s cross laser.

Laser Delay Enable

After enabling this parameter, you can enter **Laser Delay Duration** to delay the close time of the cross laser.

Light Polling

After enabling, red and while light sources will polling alternately in accordance with configured interval when code reading succeeds or before ending trigger.

White Light Enable

After enabling, the white light source is available.

Note

You should disable **Light Polling** first.

Red Light Enable

After enabling, the red light source is available.

Note

- You should disable **Light Polling** and **White Light Enable** first.
 - After disabling **Light Polling**, the device uses red light source by default.
-

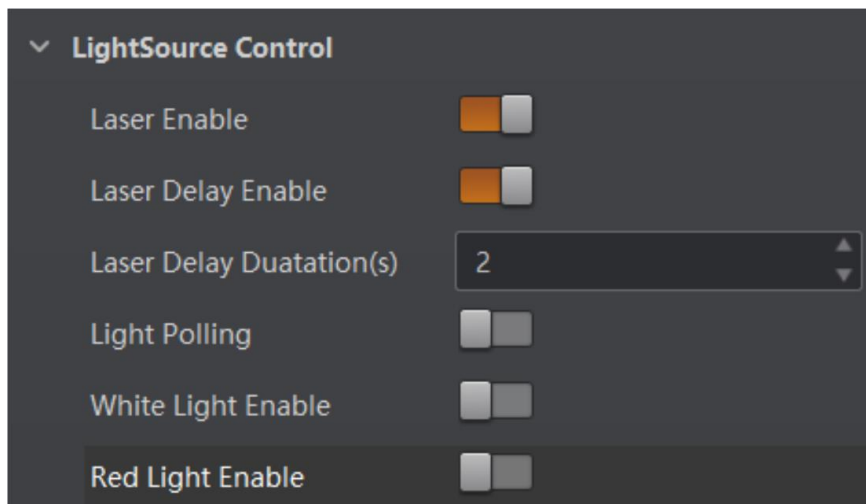

Figure 9-8 Set Light Source

Other Type of Devices

Regarding other type of devices, you can set the following parameters.

Laser Enable

It enables or disables the device's cross laser.

Laser Delay Enable

After enabling this parameter, you can enter **Laser Delay Duration** to delay the close time of the cross laser.

Light Enable

After enabling, the light source is available.

9.4.5 Set Mirror X

The device supports the mirror X function. If this function is enabled, the image will be reversed in a horizontal way.

Go to **Image Settings**, click **All Features** to display other features, and set **Mirror X** according to actual demands.

Note

This function is enabled by default, and it may differ by device models.

9.4.6 Set Test Pattern

Test pattern helps troubleshooting image problems and images in the test pattern are only for test. When exceptions occur in images acquired by the device in real time, you can check if images in the test pattern have similar problems to determine the cause of an exception.

Note

- The test pattern is available in the test or raw device mode.
 - Specific parameters of this function may differ by device models.
-

Go to **Image Settings**, click **All Features**, find **Test Pattern** in **Other Features**, and set **Test Pattern** according to actual demands.

9.5 Code Algorithm Settings

The code reader supports reading multiple types of 1D code and 2D code, and you can add and set code parameters via the client software.

9.5.1 Add Code

Adding code before you set code parameters via the client software. In **Algorithm Settings**, you can add different types of codes according to actual demands.

In **Algorithm Settings**, click **Add Barcode**, select the types of codes to be read, and set the **1D Code Number** and **2D Code Number** according to actual demands.

Note

- For different models of the device, the specific parameters may differ, and the actual device you purchased shall prevail.
- Selected symbology amount and added code amount may affect the code recognition time. Note that selecting more symbologies or adding more codes may consume more time to recognize codes in the image.
- No matter 1D code or 2D code, up to 20 codes can be added at a time. Note that adding more codes may consume more time to recognize codes in the image. Therefore, the

code number is recommended to be set according to the actual demands.

- The code reader may output actual code number when the mismatch between the actual code number and the code number set in the client software occurs.
-

9.5.2 Set Algorithm Parameter

Click **All Features** on the upper-right to display all algorithm parameters.

Note

For different models of the device, the specific parameters may differ, and the actual device you purchased shall prevail.

Timeout Value

Timeout value refers to the maximum running time of algorithm, and its unit is ms. The code reader will stop parsing the images and return results if the time is exceeded the waiting time configured.

Code Color

It defines the readable code color. **White Code On Black Wall** means that the client software can recognize the white code with black background. **Black Code On White Wall** means that the client software can recognize the black code with white background.

Code 39 Check

Enable this parameter if Code 39 uses the parity bit.

Note

You need to select **Code 39** in **Add Barcode**.

ITF 25 Check

Enable this parameter if ITF 25 uses the parity bit.

Note

You need to select **ITF 25** in **Add Barcode**.

Accurate Timeout Enable

If it is enabled, the accuracy of algorithm timeout will improve.

9.6 Signal Input Settings

Note

The specific parameters may differ by device models and firmware versions.

In the signal input module, you can set the trigger related parameters. In general, the device supports three different trigger sources, including LineIn1 input, response trigger, and self trigger.

- LineIn1 input: Press the trigger switch to let the device trigger.
- Response trigger: When the brightness of the field of view changes, code reading and barcode output are automatically triggered. The device monitors the change of image brightness value in real time and starts code reading when the change exceeds the configured sensitivity threshold.
- Self trigger: The trigger is executed by itself according to the configured trigger time interval and number of times.

9.6.1 Set and Execute Hardware Trigger

Steps

1. Click **I/O Control Settings** → **Input** → **Trigger Mode**.
2. Select **On** as **Trigger Mode**.
3. Select **LineIn1** as **Trigger Source**.
4. Set **Debounce Time**, **Start Delay Time**, **End Delay Time**, and **Line Out Trigger In Polarity** according to actual demands.

Note

- Debounce time allows the device to filter out unwanted short external trigger signal that is input to the device.
 - If configured **Debounce Time** is greater than the pulse width of trigger signal, then this trigger signal will be ignored. Otherwise, the trigger signal will be outputted after delay.
-

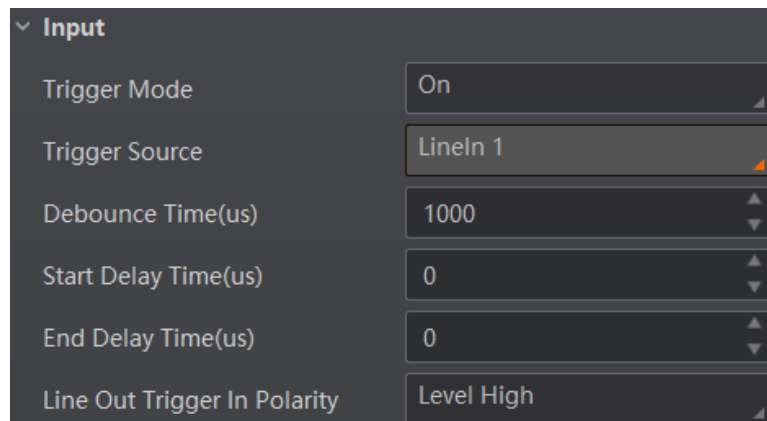

Figure 9-9 Set and Execute Hardware Trigger Mode

9.6.2 Set and Execute Response Trigger

Steps

1. Click **I/O Control Settings** → **Input** → **Trigger Mode**.
2. Select **On** as **Trigger Mode**.
3. Select **Response Trigger** as **Trigger Source**, and set **Trigger Sensitivity** accordingly.

9.6.3 Set and Execute Self Trigger

Before you start: The device cannot execute self trigger if read code method is batch mode. Thus, make sure that the device's read code method is not in batch mode when using self trigger.

Steps

1. Click **I/O Control Settings** → **Input** → **Trigger Mode**.
2. Select **On** as **Trigger Mode**.
3. Select **Self Trigger** as **Trigger Source**, set **Self Trigger Period** and **Self Trigger Count** accordingly.

Note

- Self trigger period should be greater than the reciprocal of the actual frame rate.
 - The device will trigger indefinitely until the execution of the self trigger stop.
4. Click **Execute** in **Self Trigger Start** to let the device perform the trigger operation with configured **Self Trigger Period** and trigger will automatically stop when trigger count reaches configured **Self Trigger Count**.
 5. (Optional) Click **Execute** in **Self Trigger Stop** to stop trigger.

Note

You can use the device's trigger switch to start and stop self trigger.

9.6.4 Set and Execute Software Trigger

In software trigger, the software sends trigger signal to the device to acquire images.

Steps

1. Click **I/O Control Settings** → **Input** → **Trigger Mode**.
2. Select **On** as **Trigger Mode**.
3. Select **Software** as **Trigger Source**.
4. Click **Execute** in **Trigger Source** to send trigger commands.
5. (Optional) Enter **Auto Trigger Time**, and then enable **Enable Auto Trigger** to let the client software automatically send trigger signal to device according to the interval you set.

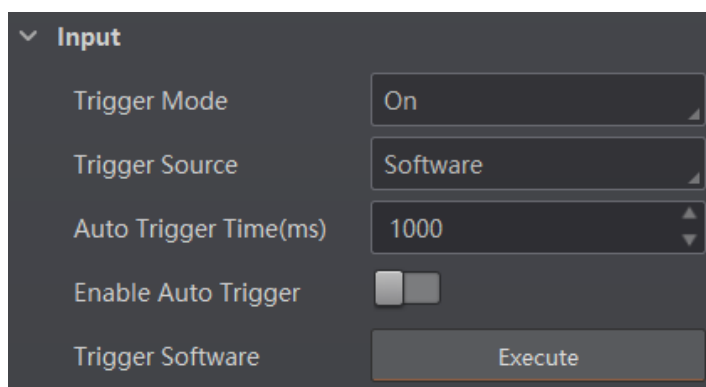

Figure 9-10 Set and Execute Software Trigger

9.7 Code Reading Result Settings

In **Data Processing** module, you can set filter rules for reading codes and other data processing related parameters.

9.7.1 Set Filter Rule

You can set rules to filter unwanted codes to improve the reading efficiency in **Filter Rule**.

Note

The filter rule parameters may differ with different device modes and trigger modes.

When the device mode is **Normal** and **Trigger Mode** is **On**, you can set the following parameters according to actual demands.

Min. Output Time

It sets the min. waiting time before data output. For example, if you set 500 ms as **Min. Output Time**, the code would not be outputted until 500 ms is passed.

Numeral Filter

If this parameter is enabled, the device will only parse and read the numeral contents of the codes, and the non-numeral contents will be filtered out.

Max. Output Length

It sets the max. length of code that can be output.

Code Offset Num

It sets the range of code to be filtered. For example, the code is ABCDEFG, if you set this parameter as 2, the device will output CDEFG at last and filter AB.

Begin with Specific Character for Result

If this parameter is enabled, the device will only read the codes which begin with a specific character. Otherwise, the codes will be filtered out. You can enter the specific character

in **Begin with**.

Include Specific Character in Code

If this parameter is enabled, the device will only read the codes which include a specific character. Otherwise, the codes will be filtered out. You can enter the specific character in **Character**.

Exclude Specific Character in Code

If this parameter is enabled, the device will only read the codes which exclude a specific character. Otherwise, the codes will be filtered out. You can enter the specific character in **Character**.

Regular Expression Filter Enable

If this parameter is enabled, the device will only read the codes which contain a specific regular expression. You can enter the specific regular expression in **Regular Expression Filter Rules**.

Min. Code Length

If the length of a code is shorter (in terms of the number of characters contained in the code) than the configured value, the device will not parse the contents of the code. The valid value is from 1 to 256. For example, if you set the value as 6, the device will not parse the contents of the codes which contain less than 6 characters.

Max. Code Length

If the length of a code is longer ((in terms of the number of characters contained in the code) than the configured value, the device will not parse the contents of the code. The valid value is from 1 to 256. For example, if you set the value as 9, the device will not parse the contents of the codes which contain more than 9 characters.

Read Times Threshold

If the reading results of a code is same for the configured times, the code will be regarded as valid and its reading result will be outputted. Or the code will be regarded as invalid and its reading result will not be outputted.

Reread Filtering Enable

If it is enabled, duplicated code information within the specified quantity and time will be filtered.

Reread Filtered Code Quantity

The device will filter out duplicated codes according to configured code quantity here. For example, if this parameter is 20, then the duplicated code within 20 codes will be filtered.

Reread Filter Time (ms)

The duplicated codes will be filtered out in this configured time.

Reset Reread Filtered Code

Click **Execute** here to reset configured **Reread Filtered Code Quantity** and **Reread Filter Time (ms)**.

9.7.2 Set Result Format

Result format settings allow you to set the format and contents contained in the outputted code information. Result format is related to communication protocol and trigger mode. With different selected communication protocol and trigger mode, you need to set corresponding parameters. Here we use normal device mode and trigger is on as an example to introduce corresponding parameters.

Note

- The supported communication protocols may differ by device models.
 - Result format settings are only available if you select **TCP Client**, **Serial**, **FTP**, **TCP Server**, **HTTP**, **Profinet**, **MELSEC**, **Ethernet/IP**, **ModBus**, **UDP**, **Fins**, **USB**, and **SLMP** as the communication protocol when device mode is **Normal**. Result format settings are not available for **Smart SDK**.
 - For details about communication protocol, see section **Communication Settings** for details.
-

Result Output via Smart SDK

When the communication protocol is **Smart SDK**, device mode is **Normal** and trigger mode is **On**, you just need to set **NoRead Image Index** in the **Data Processing**.

Note

The configurable parameters may differ if the internal trigger mode is enabled.

NoRead Image Index

It sets the specific image that is outputted when no code information is read. For example, if you set this parameter as 5, and the 5th image will be output.

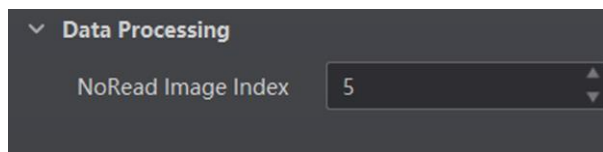

Figure 9-11 Result Output via Smart SDK

Result Output via FTP

If FTP is selected as **Communication Protocols**, you need to set following parameters.

Note

The configurable parameters may differ by the trigger mode, and here we take the external trigger mode as an example.

NoRead Image Index

It sets the specific image that is outputted when no code information is read. For example, if you set this parameter as 5, and the 5th image will be output.

Output Retrans Enable

If this parameter is enabled, the data is allowed to retransmit to FTP server, and should set specific value in **Output Retrans Number**.

Note

If data retransmission is still failed after the times allowed for data retransmission is reached, the retransmission will be discarded.

FTP Transmission Conditions

It sets the condition to upload the data outputted by the device to FTP server. **All** refers to upload the data always. **Read Code** refers to upload the data only when the code is read by the device. **No Read Code** refers to upload the data only when no code is read by the device.

FTP Transmission Result Contain

It selects contents to upload to the FTP server. **Just Result** refers to only upload the content of the code. **Just Picture** refers to only upload the code picture. **Result and Picture** refers to upload both the content of the code and the picture.

FTP Image Format

It sets the format of the picture uploaded to FTP server.

Note

The device currently support JPG format only.

FTP File Default Name

It refers to the default name of the file uploaded to FTP server. You can set it according to actual condition.

FTP File Separator

It refers to the separator that separates file name. You can set it according to actual condition.

FTP File Name Contain Package Number Enable

If this parameter is enabled, the name of the file uploaded to FTP server will contain the package ID.

FTP File Name Contain Barcode Number Enable

If this parameter is enabled, the name of the file uploaded to FTP server will contain the number of the code.

FTP File Name Contain Barcode Info Enable

If this parameter is enabled, the name of the file uploaded to FTP server will contain the

name of the package.

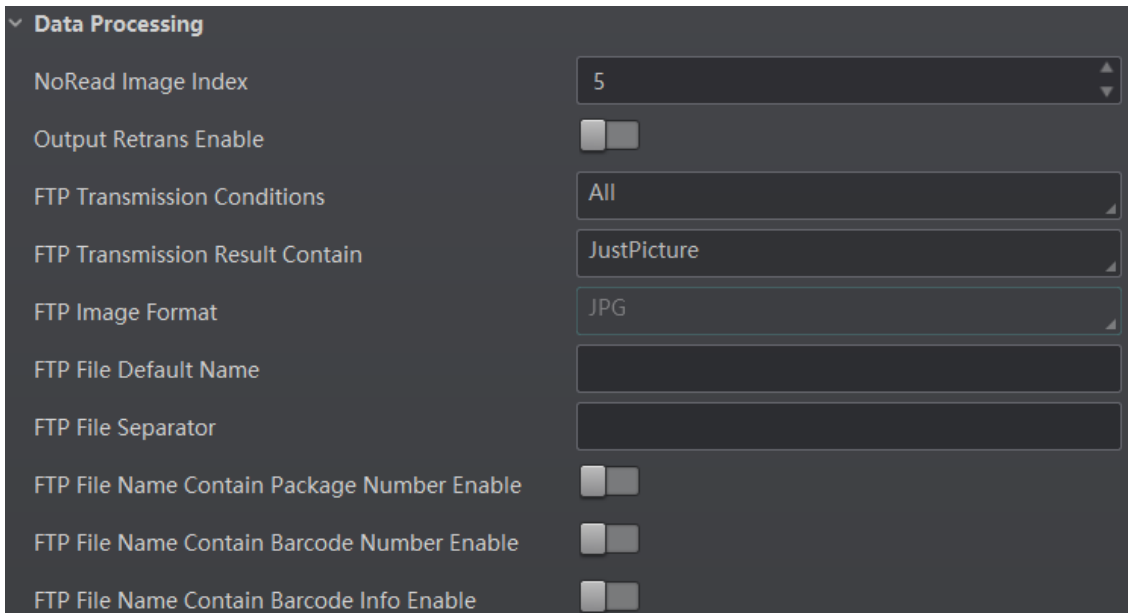

Figure 9-12 Result Output via FTP

Result Output via TCP Client, TCP Server, Serial, HTTP, MELSEC, Profinet, Ethernet/IP, ModBus, UDP, FINS, SLMP or USB

If TCP Client, TCP Server, Serial, HTTP, MELSEC, Profinet, Ethernet/IP, ModBus, UDP, FINS, SLMP or USB is selected as **Communication Protocols**, you need to set following parameters.

Note

- The configurable parameters may differ by the trigger mode, and here we take the external trigger mode as an example.
 - When the communication protocol is **TCP Client, TCP Server, Serial, HTTP, MELSEC, Profinet, Ethernet/IP, ModBus, UDP, FINS, SLMP** or **USB** the configurable parameters are similar with slight difference in term of parameter names. Here we take **TCP Client** as **Communication Protocols** as an example, and refer to the actual device you got for details.
-

TCP Output Format Flag Add

It selects what contents you want to output, including code content, code type, angle, trigger start time, code score, etc. You can select multiple contents as desired.

TCP Format Check

You should click **Execute** in **TCP Format Check** to check if you entered is right in format, and the check result will be displayed in **TCP Format Check Result**.

NoRead Image Index

It sets the specific image that is outputted when no code information is read. For example,

if you set this parameter as 5, and the 5th image will be output.

TCP Output NoRead Enable

If it is enabled, and the device will output the content you set in **TCP Output NoRead Text** when no code is recognized.

TCP Output Start Text

The contents of the start part of the data outputted. You can set the contents according to actual condition.

TCP Output Stop Text

The contents of the end part of the data outputted. You can set the contents according to actual condition.

TCP Output Barcode Enter Character Enable

If it is enabled, carriage return will be added at the last of a trigger number.

TCP Output Barcode Newline Character Enable

If it is enabled, a newline will be added at the last of a trigger number.

9.8 Communication Settings

The communication protocol is used to transmit and output code reading result and image. The communication protocol is related to the device modes. With various device modes, the device supports different communication protocols and corresponding parameters.

When device mode is **Test** or **Raw**, the device only supports **SmartSDK** protocol and no parameter settings are required. While in **Normal** mode, the device supports **SmartSDK, TCP Client, Serial, FTP, TCP Server, HTTP, Profinet, MELSEC, Ethernet/IP, ModBus, UDP, Fins, USB, and SLMP** communication protocols, and you need to set corresponding parameters.

Note

- The supported communication protocols may differ by device models.
 - The specific parameters of communication protocols may differ by device models.
-

9.8.1 Smart SDK

If **Smart SDK** is selected as the **Communication Protocols**, you can enable **SmartSdk Protocol** to let the device output data via **Smart SDK**.

Encode JPG Flag

If enabled, the device will compress the image data.

Quantity of Jpg

You can enter a number (range: 50 to 99) to determine the compression quality

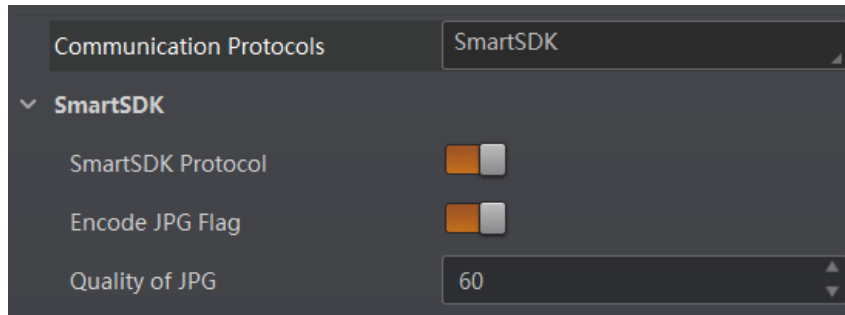

Figure 9-13 Smart SDK

9.8.2 USB

If **USB** is selected as the **Communication Protocols**, you can enable **USB Enable**, set **USB Output**, **USB Baudrate**, **USB Data Bits**, **USB Parity**, and **USB Stop Bits**.

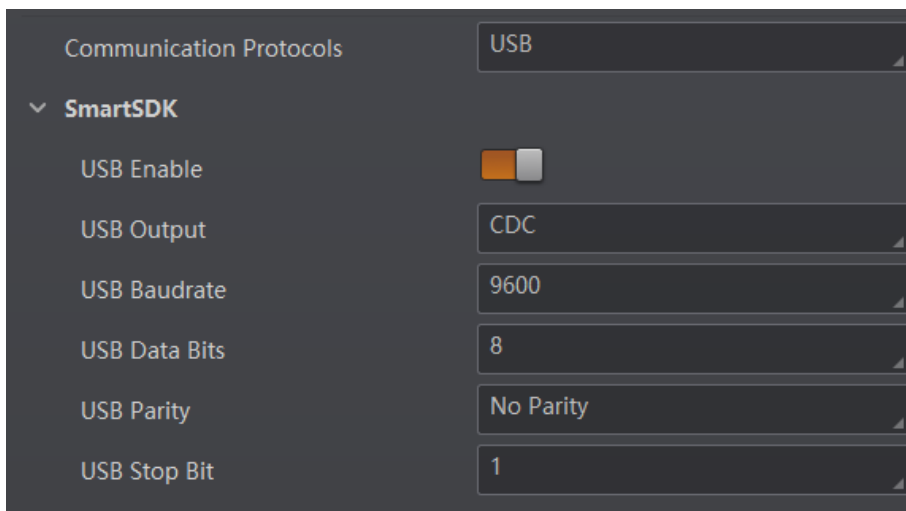

Figure 9-14 USB

 **Note**

USB Baudrate, **USB Data Bits**, **USB Parity**, and **USB Stop Bits** are displayed only when the **USB Output** is **CDC**.

9.8.3 TCP Client

If select **TCP Client** as the **Communication Protocols**, you need to set following parameters.

Output Result Buffer: If enabled, when the TCP server is abnormal, the device will cache the images. When the server returns to normal, the device will send the cached images to the server. After this parameter being enabled, you can set **Output Result Buffer Number** to determine the number of the images that the device will cache.

You can also enable **TCP Protocol**, enter **TCP Dst Addr** and **TCP Dst Port**.

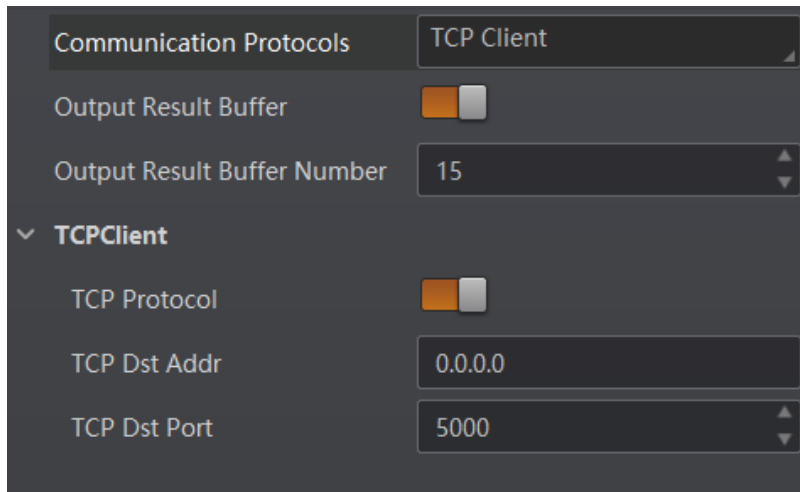

Figure 9-15 TCP Client

9.8.4 Serial

If **Serial** is selected as the **Communication Protocols**, you can enable **Serial Protocol**, enter **Serial Baud Rate**, **Serial Data Bits**, **Serial Parity**, and **Serial Stop Bits**.

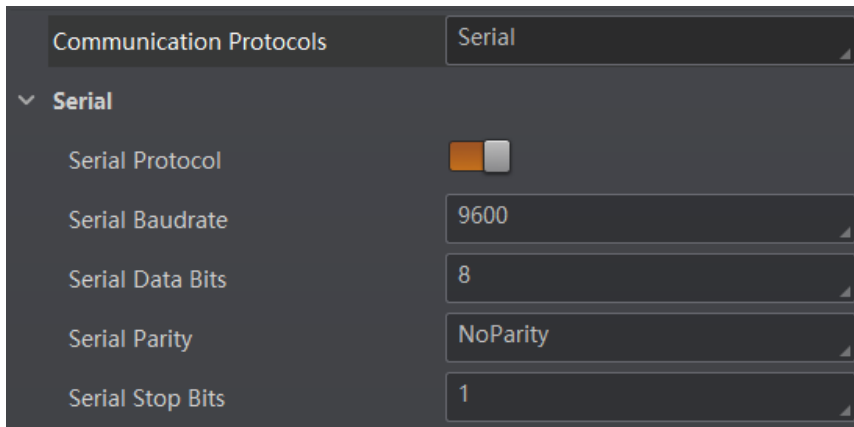

Figure 9-16 Serial

9.8.5 FTP

If select **FTP** as the **Communication Protocols**, you need to set following parameters.

Output Result Buffer: If enabled, when the FTP server is abnormal, the device will cache the images. When the FTP server returns to normal, the device will send the cached images to the server. After this parameter being enabled, you can set **Output Result Buffer Number** to determine the number of the images that the device will cache.

You can also you can **enable FTP Protocol**, enter **FTP Host Addr**,**FTP Host Port**, **FTP User Name**, and **FTP User PWD**.

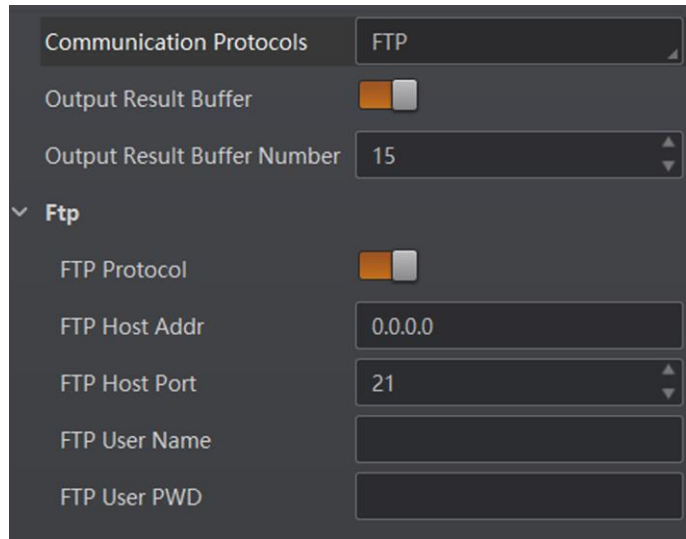

Figure 9-17 FTP

9.8.6 HTTP

If select **HTTP** as the **Communication Protocols**, you can enable **HTTP Server**, enter **HTTP Sever Port** and **WebRefresh Cycle**.

HTTP Server

If enabled, the device will output data via HTTP server.

HTTP Server Port

Enter the port No. of the HTTP server.

WebRefresh Cycle

Set the frequency to refresh the Web.

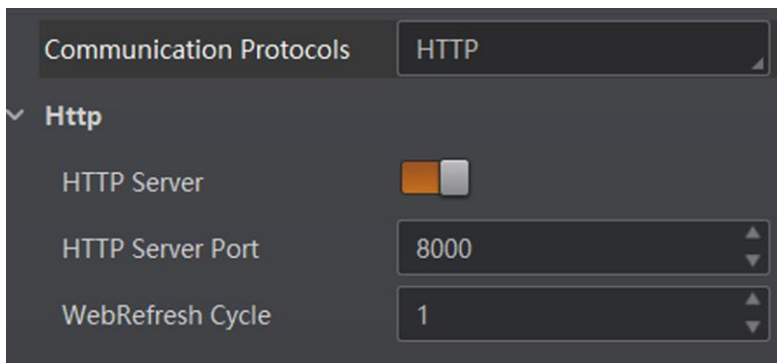

Figure 9-18 HTTP

9.8.7 TCP Server

If **TCP Server** is selected as the **Communication Protocols**, you can enable **TCP Server Enable**, and enter **TCP Server Port**.

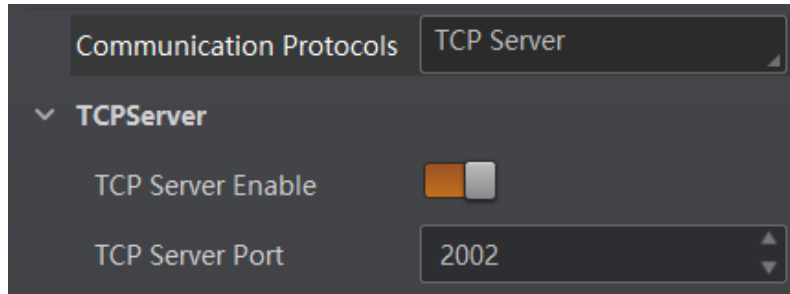

Figure 9-19 TCP Server

9.8.8 Profinet

If **Profinet** is selected as the **Communication Protocols**, you can enable **Profinet Enable** and set **Profinet Device Name** according to actual demands.

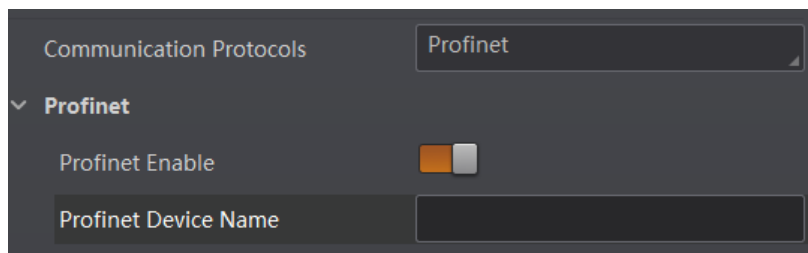

Figure 9-20 Profinet

9.8.9 MELSEC

If **MELSEC** is selected as the **Communication Protocols**, you can enable **MELSEC Enable** and set related parameters according to actual demands.

MELSEC Server IP

It sets the IP address of MELSEC server.

MELSEC Server Port

It sets the port number of MELSEC server.

MELSEC Frame Type

It sets frame type of MELSEC.

MELSEC Network Number

It sets the network number of MELSEC.

MELSEC Node Number

It sets the node number of MELSEC.

MELSEC Processor Number

It sets processor number.

MELSEC Control Poll Interval (ms)

It sets how often read data of the control area.

MELSEC Control Space

It sets storage space of the control area.

MELSEC Control Offset

It sets the start offset address of the control area.

MELSEC Control Size (Word)

It sets the size of the control area.

MELSEC Status Space

It sets storage space of the control area.

MELSEC Control Offset

It sets the start offset address of the control area.

MELSEC Control Size (Word)

It sets the size of the control area.

MELSEC Result Space

It sets storage space of the result area.

MELSEC Result Offset

It sets the start offset address of the result area.

MELSEC Result Size (Word)

It sets the size of the result area.

MELSEC Result Byte Swap

If it is enabled, the client software will swap MELSEC results.

MELSEC Result Timeout

It sets the MELSEC result timeout, and the unit is s.

9.8.10 Ethernet/IP

If **Ethernet/IP** is selected as the **Communication Protocols**, you can enable **Ethernet/IP Enable**, and the device will output data via Ethernet/IP.

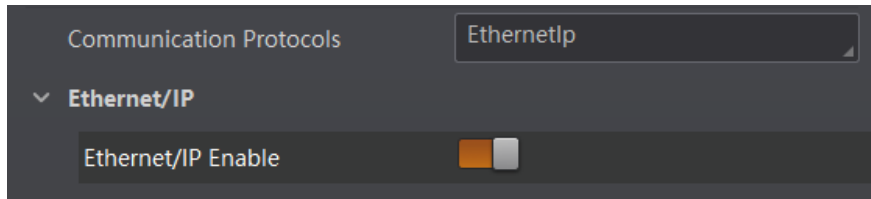

Figure 9-21 Ethernet/IP

9.8.11 ModBus

If **ModBus** is selected as the **Communication Protocols**, you can enable **ModBus Enable** and set related parameters according to actual demands.

ModBus Mode

It includes server and client, and is server by default.

Note

If client is selected as **ModBus Mode**, you need to set **ModBus Server IP** and **ModBus Server Port**.

ModBus Control Space

It is holding_register by default.

ModBus Control Offset

It refers to the address offset, and is 0 by default.

ModBus Control Size (Word)

It is 1 by default.

ModBus Status Space

It is holding_register by default.

ModBus Status Offset

It is 1 by default.

ModBus Status Size (Word)

It is 1 by default.

ModBus Result Space

It is holding_register by default.

ModBus Result Offset

It is 2 by default.

ModBus Result Size (Word)

It sets max. length of ModBus result. It is 100 by default.

ModBus Result Byte Swap

If it is enabled, the client software will swap ModBus results.

ModBus Result Timeout (s)

It sets the ModBus result timeout, and the unit is s.

9.8.12 UDP

If **UDP** is selected as the **Communication Protocols**, you can enable **UDP Protocol Enable**, and set **UDP Dst IP** and **UDP Dst Port**.

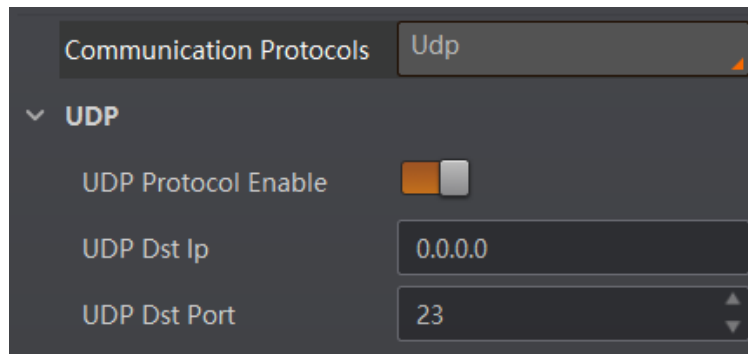

Figure 9-22 UDP

9.8.13 Fins

If **Fins** is selected as the **Communication Protocols**, you can enable **Fins Enable** and set related parameters according to actual demands.

Fins Server IP

It sets the server IP of Fins.

Fins Server Port

It is 9600 by default.

Fins Control Poll Interval (ms)

It sets how often read data.

Fins Control Space

It sets storage space of the control area.

Fins Control Offset

It sets the start offset address of the control area.

Fins Control Size (Word)

It sets the size of the control area.

Fins Status Space

It sets storage space of the status area.

Fins Status Offset

It sets the start offset address of the status area.

Fins Status Size (Word)

It sets the size of the status area.

Fins Result Space

It sets storage space of the result area.

Fins Result Offset

It sets the start offset address of the result area.

Fins Result Size (Word)

It sets the size of the result area.

Fins Result Byte Swap

If it is enabled, the client software will swap Fins results.

Fins Result Timeout (s)

It sets the Fins result timeout, and the unit is s.

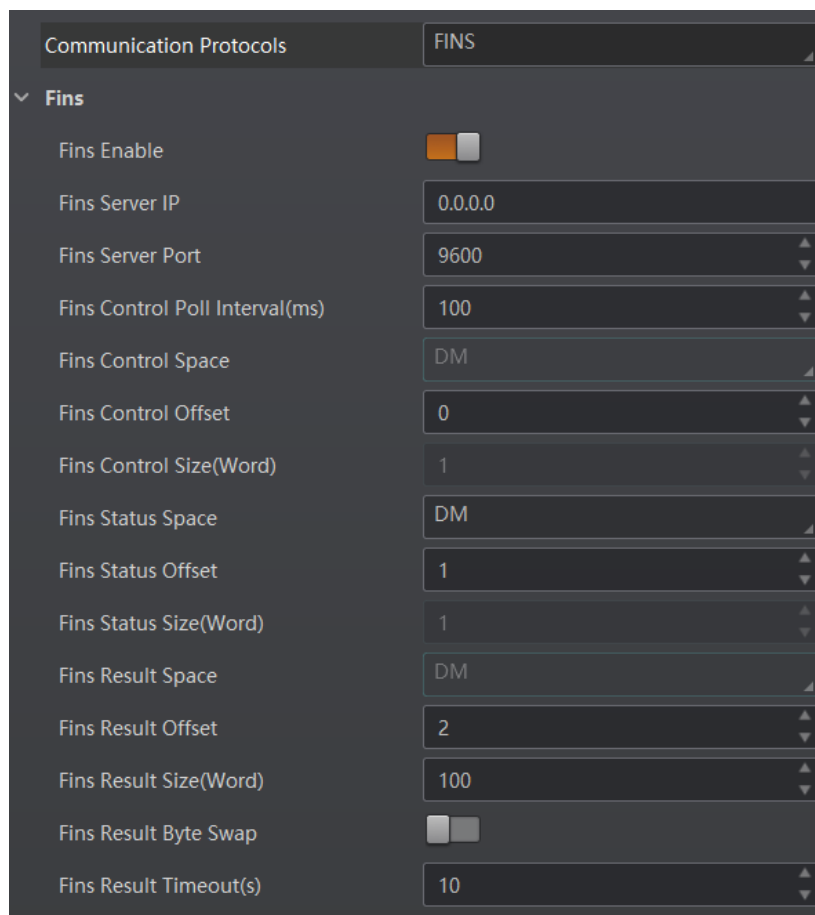

Figure 9-23 Fins

9.8.14 SLMP

If **SLMP** is selected as the **Communication Protocols**, you can enable **SLMP Enable** and set related parameters according to actual demands.

SLMP Server IP

It sets the IP address of SLMP server.

SLMP Server Port

It sets the port number of SLMP server.

SLMP Frame Type

It sets frame type of SLMP.

SLMP Network Number

It sets the network number of SLMP.

SLMP Node Number

It sets the node number of SLMP.

SLMP Processor Number

It sets processor number.

SLMP Control Poll Interval (ms)

It sets how often read data of the control area.

SLMP Control Space

It sets storage space of the control area.

SLMP Control Offset

It sets the start offset address of the control area.

SLMP Control Size (Word)

It sets the size of the control area.

SLMP Status Space

It sets storage space of the control area.

SLMP Control Offset

It sets the start offset address of the control area.

SLMP Control Size (Word)

It sets the size of the control area.

SLMP Result Space

It sets storage space of the result area.

SLMP Result Offset

It sets the start offset address of the result area.

SLMP Result Size (World)

It sets the size of the result area.

SLMP Result Byte Swap

If it is enabled, the client software will swap SLMP results.

SLMP Result Timeout

It sets the SLMP result timeout, and the unit is s.

9.9 User Set Customization

The Configuration Management module allows you to set and manage the user set. A user set is a group of parameter values with all the settings needed to control the device, and you can save, load and switch different user sets.

Save Settings

If you have set the device parameters as desired, you can save them into the user set. Go to **Config Management** → **Save Settings**, and click **UserSet1**, **UserSet2**, or **UserSet3** to save the current device settings.

Load Settings

You can load the user set to restore the device to the saved group of parameter values again if required. Go to **Config Management** → **Load Settings**, and click **Default**, **UserSet1**, **UserSet2**, or **UserSet3** to load settings.

Note

The **Default** refers to restore the device parameter settings to the factory ones.

Start Settings

The selected user set will be automatically loaded after the device being powered on. For example, if you select **Default**, the device parameter settings will be restored to the factory settings.

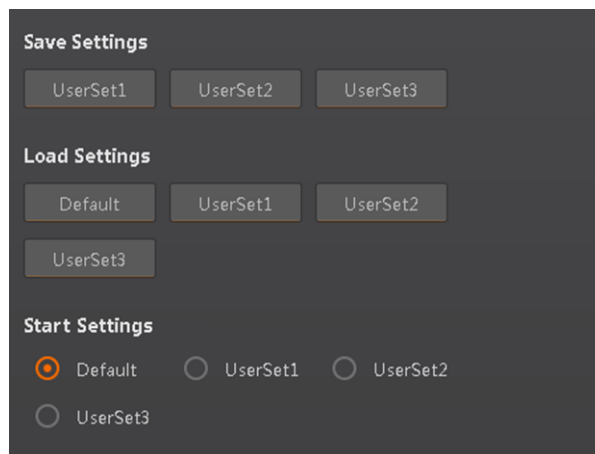

Figure 9-24 User Set Customization



Chapter 10 Device Operation

The device operation section introduces some basic device operations about how to start live view, acquisition and recording, cross line in the image, split window, view reports, etc.

Note

Connecting the device to the client software is required before device operation.

10.1 Live View

You can view the real-time image in the live view window. Click  in live view window to start live view, or click  to stop.

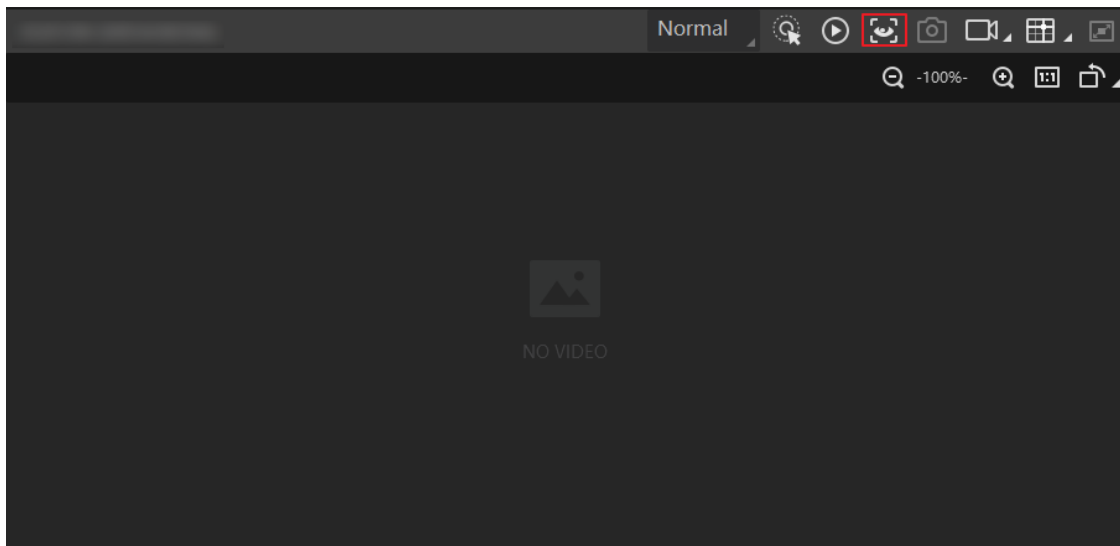



Figure 10-1 Live View

10.2 Enable Acquisition

Enabling acquisition allows the device to acquire the real-time stream. Click  in live view window to start acquisition, or click  to stop. You can also right click the device on the device list, and click **Stop Acquisition** to stop acquiring streams.

Note

Acquisition is still going on if you only stop live view.

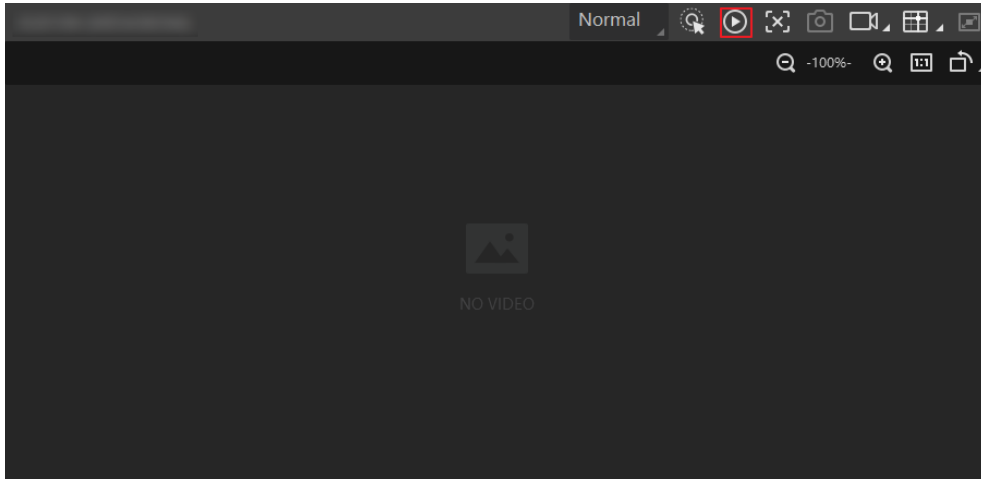

Figure 10-2 Enable Acquisition

10.3 Add Cross Line



During live view, you can add a cross line on the live view image to adjust the position of the object in the view. Click  in live view window to add cross line, and click  (beside ) to open the editing window to set cross line parameters.







Figure 10-3 Add Cross Line

10.4 Start Recording

During live view, you can record video files and capture images continuously.

 **Note**

Enabling acquisition is required before recording.

Click  in live view window to start recording, and click the icon again to stop. You can also click  (beside ) , and then click  to capture images of the live view continuously.

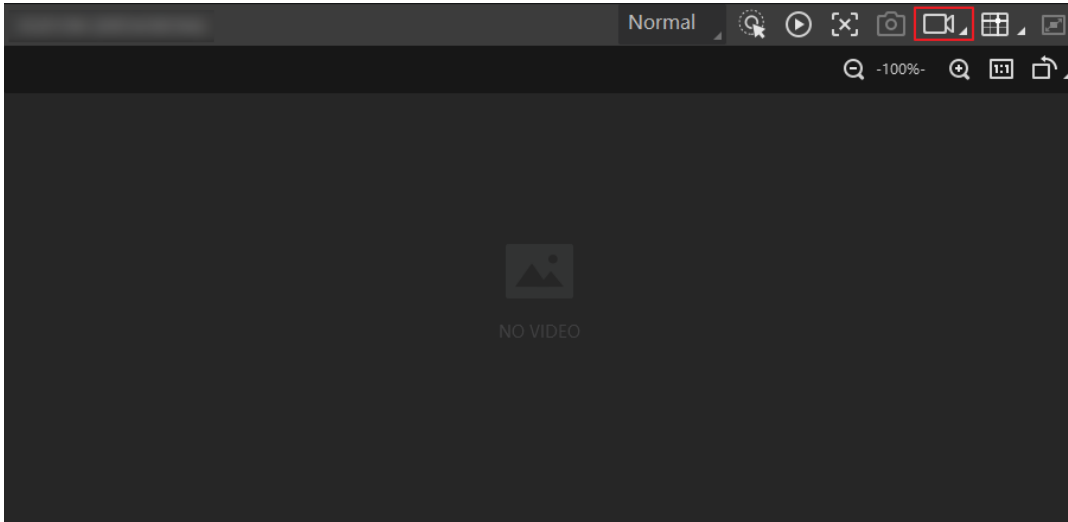



Figure 10-4 Start Recording

10.5 Split Window

The client software supports window division function that allows you to split the window into multiple-window mode to view the live view of multiple devices at the same time. Click  in control toolbar to select window division mode. You can click **Custom** to customize window division as you desired.

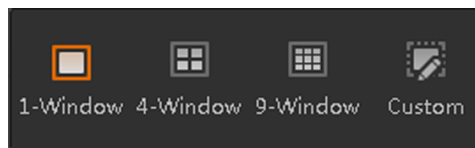



Figure 10-5 Split Window

10.6 View Reports

During acquisition or live view, you can view the reading status of the device. Click  in control toolbar to open the statistics window to view the detailed information. **Read Code Images** refers to the number of the images on which the codes are read by the device. **Unread Code Images** refers to the number of the images on which the codes are not read by the device. **Read Rate** refers to the code reading rate.

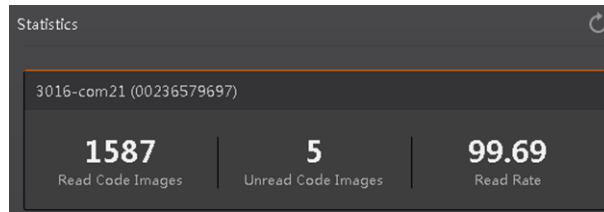



Figure 10-6 View Reports

10.7 View Log

You can view the device logs and export them to the local PC. Click  in control toolbar to open the device log window, and you can view different types of logs, including device errors, warning, and informational log, etc.

The screenshot shows the 'Camera Log' window for device 'test-X86 (168895)'. It features a filter bar with checkboxes for Error, Warning, Info, All, and Null, along with 'Export Log' and 'Refresh Log' buttons. The log entries are as follows:

Type	Time	Content	Source
Info	2019-06-19 17:26:05:0216	dir is : (D:\SmartCamera\0\SmartCameraLog\), time is (...	SmartConfig.cp...
Info	2019-06-19 17:26:05:0216	Read command export log file!	Manager.cpp ...
Error	2019-06-19 17:23:00:0742	Over and current time is [179774033.858915]ms!	SmartConfig.cp...
Info	2019-06-19 17:23:00:0742	no need to compress again! time:918.756448(ms).	SmartConfig.cp...
Info	2019-06-19 17:23:00:0742	Read command export log file!	Manager.cpp ...
Error	2019-06-19 17:23:00:0742	Over and current time is [179774033.695433]ms!	SmartConfig.cp...
Error	2019-06-19 17:23:00:0742	log file len:461356!	SmartConfig.cp...
Info	2019-06-19 17:22:59:0822	dir is : (D:\SmartCamera\0\SmartCameraLog\), time is (...	SmartConfig.cp...
Info	2019-06-19 17:22:59:0822	Read command export log file!	Manager.cpp ...
Info	2019-06-19 17:21:53:0652	The package(22) frame (56396) identify BCR codenum...	BcrProc.cpp ...
Info	2019-06-19 17:14:48:0384	The package(22) frame (45763) identify BCR codenum...	BcrProc.cpp ...

Figure 10-7 View Log

10.8 Set Time

After enabling NTP time synchronization, the device will synchronize time according to the configured interval.

Steps

1. Go to **Config Management**, and find **Timing**.
2. Click **Setting** and enable **NTP Enable**.
3. Set parameters according to actual demands.

Note

Configure NTP server settings before using NTP time synchronization function.

4. Click **OK** after settings.

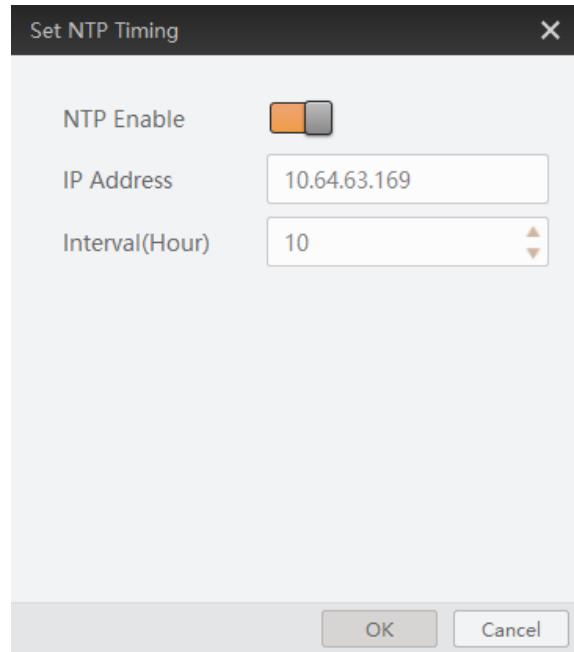

Figure 10-8 Set NTP Timing

10.9 Enable Device Auto Work

This function allows the device to automatically enter the operating status after being powered on. You can go to **Config Management** → **Device Auto Work Enable**, and enable **Device Auto Work Enable**.

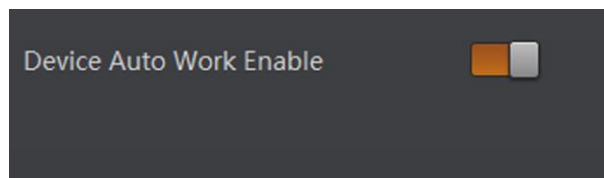

Figure 10-9 Enable Device Auto Work

Chapter 11 Device Maintenance

11.1 Update Firmware

The device supports updating firmware via the client software.

Note

- Disconnect the device with client software.
 - Please use the firmware package of the corresponding device model for upgrading.
 - Do not power off the device or disconnect network during upgrading.
 - The device will reboot automatically after updating the firmware.
-

Select the device to be updated in the device list, right click the device, and click **Firmware Update**. Click  to select update file from local PC, and click **Update** to update firmware.

Note

You can also go to **Tool** → **Firmware Updater** to update firmware.

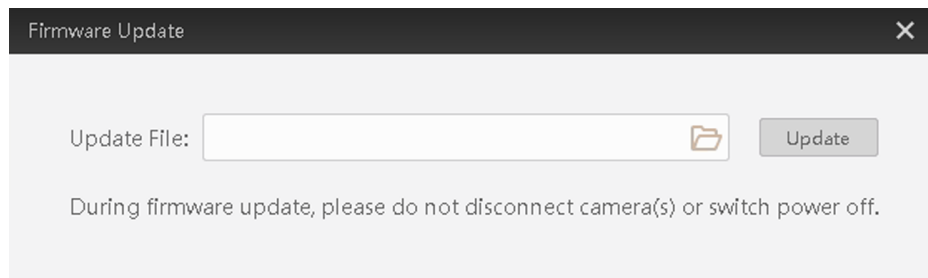

Figure 11-1 Update Firmware

11.2 Reboot Device

You can reboot the device via client software in 2 ways. Go to **Config Management**, and click **Restart Device**. Or, you can select the device to be rebooted in the device list, right click the device, and click **Device Reset**.

Chapter 12 FAQ (Frequently Asked Question)

12.1 Why there is no buzzer sound and the indicator is unlit after the device is connected?

Reason

The device's drive is not installed successfully.

Solution

Install the device's drive again.

12.2 Why the device does not read codes after powering on and getting triggered?

Reason

The function of Device Auto Work Enable is not enabled.

Solution

Go to **Config Management** → **Device Auto Work Enable**, and enable **Device Auto Work Enable**.

12.3 Why the device does not read codes after connecting to client software and getting triggered?

Reason

Acquisition is not started in the client software.

Solution

Start acquisition and trigger the device again.

12.4 Why there is no buzzer sound after the device reads

codes successfully?

Reason

The device's device mode is test mode.

Solution

Set the device mode as normal mode.

12.5 Why configuring setting codes failed though there is buzzer sound?

Reason

The function of setting codes is not activated because **Enable Setting Codes** is not scanned and read.

Solution

Before using other setting codes, you need to scan **Enable Setting Codes** first to activate the function of setting codes.

12.6 Why only a few codes read successfully on the batch code reading mode?

Reason

Improper settings in **Algorithm Settings**.

Solution

Go to **Algorithm Settings** → **Add Barcode**, set the **1D Code Number** and **2D Code Number** according to actual demands.

12.7 Why the image is very dark during the live view?

Reason

- The light source of the device is disabled.
- Too small value of exposure and gain.

Solution

- Enable the light source of the device.
- Increase exposure and gain according to actual demands.

Appendix A ASCII Table

 **Note**

The USB type device supports the red color character only regarding setting prefix and suffix characters.

Table A-1 ASCII Table

Character	Value	Character	Value	Character	Value	Character	Value
NUL	0	(SPACE)	20	@	40	`	60
SOH	1	!	21	A	41	a	61
STX	2	"	22	B	42	b	62
ETX	3	#	23	C	43	c	63
EOT	4	\$	24	D	44	d	64
ENQ	5	%	25	E	45	e	65
ACK	6	&	26	F	46	f	66
BEL	7	'	27	G	47	g	67
BS	8	(28	H	48	h	68
HT	9)	29	I	49	i	69
LF/NL	0a	*	2a	J	4a	j	6a
VT	0b	+	2b	K	4b	k	6b
FF/NP	0c	,	2c	L	4c	l	6c
CR	0d	-	2d	M	4d	m	6d
SO	0e	.	2e	N	4e	n	6e
SI	0f	/	2f	O	4f	o	6f
DLE	10	0	30	P	50	p	70
DC1/XON	11	1	31	Q	51	q	71
DC2	12	2	32	R	52	r	72
DC3/XOFF	13	3	33	S	53	s	73
DC4	14	4	34	T	54	t	74
NAK	15	5	35	U	55	u	75

Wired Handheld Code Reader User Manual

Character	Value	Character	Value	Character	Value	Character	Value
SYN	16	6	36	V	56	v	76
ETB	17	7	37	W	57	w	77
CAN	18	8	38	X	58	x	78
EM	19	9	39	Y	59	y	79
SUB	1A	:	3A	Z	5A	z	7A
ESC	1B	;	3B	[5B	{	7B
FS	1C	<	3C	\	5C		7C
GS	1D	=	3D]	5D	}	7D
RS	1E	>	3E	^	5E	~	7E
US	1F	?	3F	-	5F	DEL	7F



See Far, Go Further